



Committed to Customer Success

Always
Moving Forward



2023 Mobile Computing Solutions Product Selection Guide

www.nexcom.com



About NEXCOM

Mobile Computing Solutions

Founded in 1992, NEXCOM is committed to being your trustworthy partner in building the intelligent business. NEXCOM makes the difference by utilizing its industrial computing experience, a highly talented R&D team, strong world-class ODM services, and rapid support to customers. NEXCOM has worldwide customers from more than 50 countries and we never stop growth with our business partners. As we accelerate towards the future, NEXCOM has been playing an important role in bringing intelligence to transportation.

NEXCOM's Mobile Computing Solutions (MCS) has extended and developed many products for use in AI, 5G, and safety related applications. We're creating a safer working environment and saving operational costs through improvements in logistics for more efficient fleet management. Through the application and development of 5G, a better internet experience can be realized. We support our business partners to further promote edge AI computing for ADAS, AMR, and autonomous driving.

We focus on developing practical technologies, and constant growth brings us many advantages in the automotive sphere:

- Superior power designed for uninterrupted operations
- Smart and effective patented designs, resistant to very extreme environments
- Various communication module options (LoRa, V2X, NB-IoT, LTE, 5G NR, Wi-Fi 6/6E)

- Modular designs for the ease of maintenance
- Customized firmware and specialized ODM hardware solutions

NEXCOM has the passion, hope and dedication to keep moving forward making daily lives better through innovation. NEXCOM is forging ahead into the future and making it a success with our business partners!

Always Moving Forward



Our Core Competencies -

Building a Foundation for Interconnected IoV and Value-Added Innovation



Vehicle Mount Computer
VMC 2020



Railway Computer
aROK 5510



Railway Computer
aROK 8110

Premium Computing Design Capability

Computing power drives vehicle applications, which is why NEXCOM offers a wide range of computing platforms to meet different vehicle needs

- RISC platform (NXP i.MX6, i.MX8, Rockchip, TI)
- Intel Atom® platform (Bay Trail, Apollo Lake, Elkhart Lake, Alder Lake-N)
- Intel® Core™ i platform (Core i 8th, 9th, 11th, 12th, 13 th Gen)
- Intel® high-end Xeon® platform
- NVIDIA® Jetson TX2, Xavier™ NX, Orin™ NX, AGX Orin™ integrated
- Over 20 years of experience in designing rugged devices and vehicle/railway computers

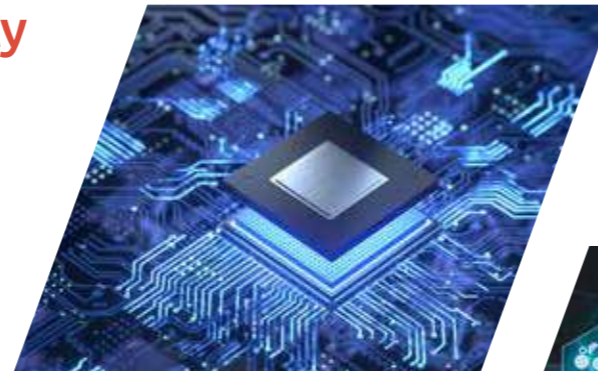

RF Communication Expansion

For the array of wireless usage cases, NEXCOM specializes in RF communication expansion, providing a comprehensive series of proprietary mini-PCIe/M.2 modules, allow users maximum flexibility in optimizing vehicle configurations

- GNSS (RTK, Dead reckoning)
- NB-IoT, 4G LTE, 5G NR
- DSRC/C-V2X, LoRa
- Wi-Fi 6/6E



Reliability Quality

- Fanless design and IP67 protection for extreme environmental conditions
- IK08 impact resistance rating on external mechanics
- Meets CISPR25 standard
- Vehicle (E mark) and railway (EN50155, EN45545-2) certifications
- CE EMC (Electromagnetic Compatibility) and FCC conducted and radiated emissions certifications
- Supporting more certifications (Safety, RED, LVD, MIL-STD-810, etc.)

Software Solutions

- SDK (API, programming guide, demo AP) supports for Linux, Android and Windows OS
- BSP (bootloader, kernel driver, OS (Android, Yocto, Ubuntu))
- MCU (customized MCU firmware for small quantities)
- BIOS (customized BIOS for small quantities)
- Secure System Development (TPM, Secure Boot, Boot Guard)



OEM/ODM Services

- Over 20 years of experience in industrial-grade computer design and manufacturing
- Seasoned design capabilities in customized system and software integration
- Certificated, 100%-owned manufacturing facilities in Taiwan
- Expertise in mobile transport technologies, with vertical domain know-how
- Acceptance of small to medium quantities, with fast time-to-market delivery

Specialization in AI Technology

- Specialize in NVIDIA® (GeForce/Quadro, PCIe x16/MXM, Jetson), Google Coral (M.2, mini-PCIe), and Hailo AI accelerators (M.2, mini-PCIe, onboard)
- Support partners to drive deeper customer engagement in AI + mobile edge computing applications
- Provide edge processing and AI capabilities to software partners/developers to innovate and create new business models



Our Product Portfolio



Product Series

- Edge AI Telematics Solution
- Vehicle Telematics Computer
- Railway Computer
- Vehicle Mount Computer
- Modular Vehicle Computer System
- Vehicle Mount Display
- In-Vehicle Networking
- In-Vehicle HDMI Extender over IP



ATC Series

Advanced Telematics Computer w/ GPU

- Designed for AI applications: ANPR, video analytics
- Selected NVIDIA GPU, MXM, Google TPU, and Hailo module add-ons
- 5G/LTE, Wi-Fi 6/6E, BT, CAN/OBD, GNSS + DR, PoE, and multi-SIM integration



VTC Series

In-Vehicle Telematics Computer

- General purpose, high-performance telematics computer
- 5G/LTE, Wi-Fi 6/6E, BT, CAN/OBD, GNSS + DR, PoE, and multi-SIM integration
- IP65/67 ingress protection
- Power management
- Backup battery kit



nROK/aROK/vROK Series

Railway Computer

- Box/Panel PC with fanless and rugged design
- 5G/LTE, Wi-Fi 6/6E, BT, CAN/OBD, GNSS + DR, PoE, and multi-SIM integration
- Optional isolated 24~110VDC power input
- EN50155 & EN45545-2 certifications



MVS Series

Modular Vehicle Computer Systems

- Modular CPU board + I/O board + expandable I/O board
- Flexible integration of LTE, Wi-Fi, BT, PoE, and other I/Os
- Easy customization of different I/O interfaces, with quick re-spins for faster time-to-market



VMC Series

Rugged Vehicle Terminal

- Driver's operational display
- Designed for outdoor applications
- Full IP65 certification
- IK08-rated screens
- Vibration-, shock-, dust-, and water-resistant
- 5G/LTE, Wi-Fi 6/6E, CAN/OBD, GNSS + DR



PoE/10G LAN and RTSP Solutions

- Extends Full HD HDMI over IP for Passenger Infotainment Systems
- Design for video surveillance and AI video analytics applications
- Comply with 802.3af/at with RJ45 or M12 connector (D, X-coded)
- Mobile PoE switch and 10G PoE cards



Premium Solutions



- IP65/IP67 protection against water and dust
- IK ratings protection provided by panel PC against external mechanical impacts to display
- Performing conformal coating protection against moisture, dust and chemicals



Internet of Vehicles (IoV)

Creating a Fully-encompassing Car Ecosystem Through IoV Innovation

Build Your Next-Gen Mobile Computing Solutions

-  Enable smart transportation and traffic infrastructure with AI inference
-  Connect to next-gen wireless 5G NR, Wi-Fi 6/6E, DSRC/C-V2X network technologies
-  Perform intelligent surveillance with event prediction and detection

First Response
AI for ANPR & Facial Recognition



AI Edge Computing
AI Vision for Inspection/People Counting



AI Edge Computing
Autonomous Driving/ADAS



5G



Smart Public Transit
Infotainment & PIS



Smart Public Transit
Infotainment & PIS



Smart Public Transit
Intelligent Video Surveillance



Wi-Fi 6/6E

Smart Public Transit
Infotainment & PIS



AI Edge Computing
AI Traffic Control & Management



V2X

Wi-Fi 6/6E

Material Handling
Positioning Management



Wi-Fi 6/6E

Logistics
Fleet Management



AI-Assisted Next-Generation Driving

Deep Learning Makes the Next-Generation Driving Perceptive and Practical



NEXCOM's Solutions

- Wide selection of GPU from NVIDIA, Google Coral, to Hailo-8
- PoE, DIO, USB, RS232/422/485 for external peripherals
- 2.5GbE/10GbE LAN port for mega data loads
- GNSS and WWAN for accurate positioning and communication
- Compliant to E-Mark, IP-grade, MIL-STD-810H for rugged environments

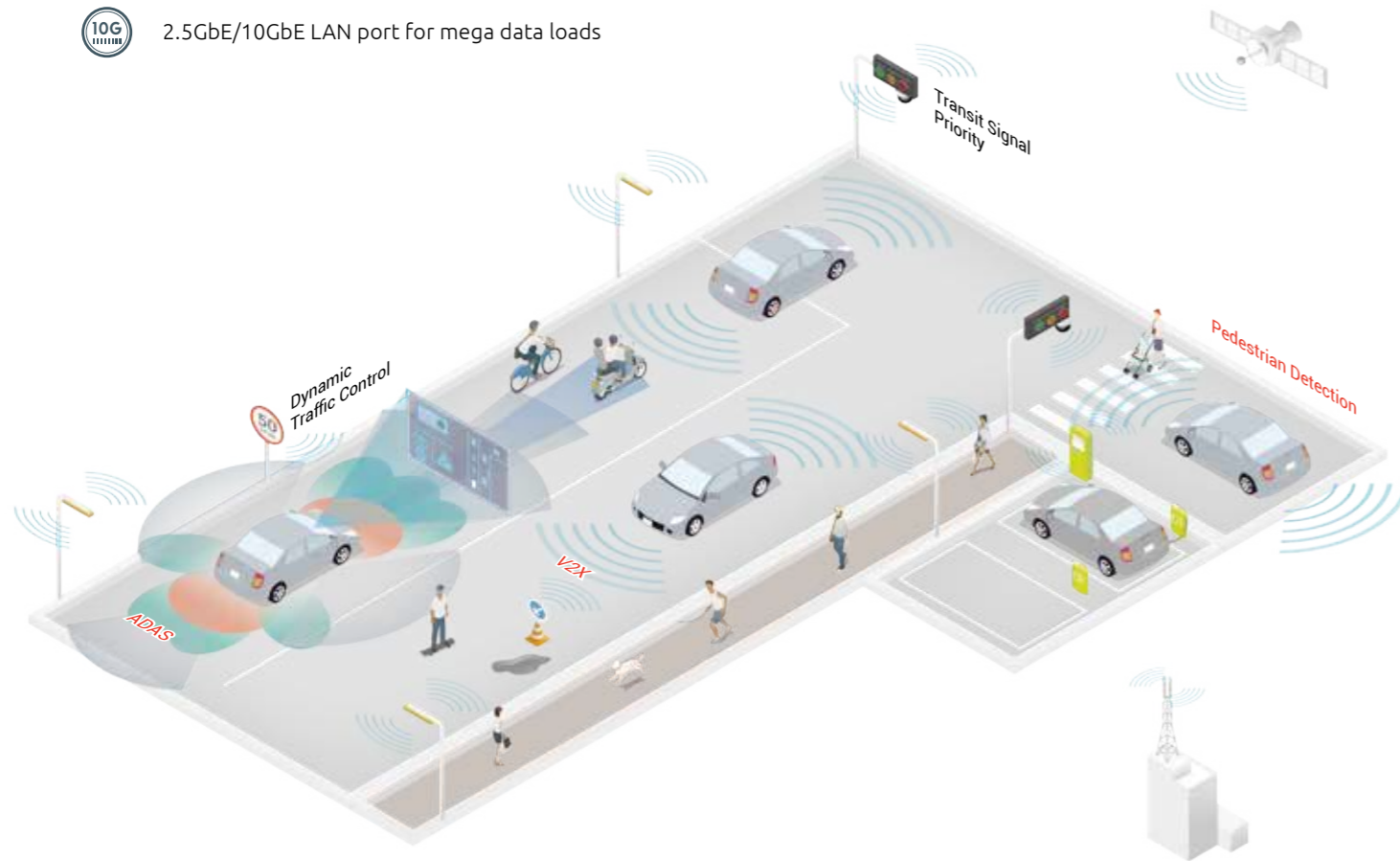

ADAS, Autonomous Driving, AMR Application Highlights

- High computing requirements for AI recognition
- Precise tracking/positioning
- Connectivity for diverse peripherals: MIPI, IP/GigE cam, LiDAR, radar
- Rugged design with add-on, built-in GPU module or SOM
- Low-latency signal transmission and rapid cloud computing access



Recommended Models

ATC 3530
 IP67 Accelerated Edge AI In-Vehicle Computer with built-in NVIDIA® Jetson Xavier™ NX SOM

- Supports 4-CH MIPI SerDes (VBO)/ cameras (up to 25m cable reach)/4-ch PoE
- Supports LTE/5G and Wi-Fi 6/6E

VTC 7260-7C4
 Fanless AI-Aided Vehicle Computer with 11th Gen Intel® Core™ CPU

- Support M.2 Hailo AI card
- Support 4-port 2.5GbE PoE+

ATC 8010
 AI Inference, In-Vehicle, Fanless Computer with Intel® Core™ 8th Gen. CPU

- Support NVIDIA® MXM GPU (Turing and Ampere-based Quadro)
- Up to 8 independent GbE PoE+

ATC 8110
 AI Powered In-Vehicle Computer, Intel® Core™ 8th/9th CPU S/Refresh

- Add-on NVIDIA graphics card RTX30xx, 40xx series (~350W)
- MIL-STD-810H for anti-vibration/shock to protect graphics card

Smart Public Bus Transit

Take a Ride to a Safe, Green, Fun, and Comfortable Tomorrow

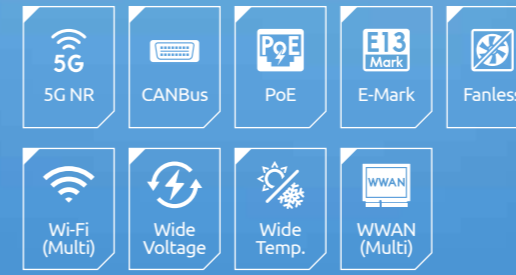

NEXCOM's Solutions

- PC-based in-vehicle NVRs for real-time surveillance
- Built-in GNSS with dead reckoning function for accurate positioning
- Built-in communication port for signage, card readers, and safety sensors
- Support multiple Wi-Fi and cellular modules for uninterrupted internet connection
- In-vehicle HDMI extender over IP for PIS and infotainment

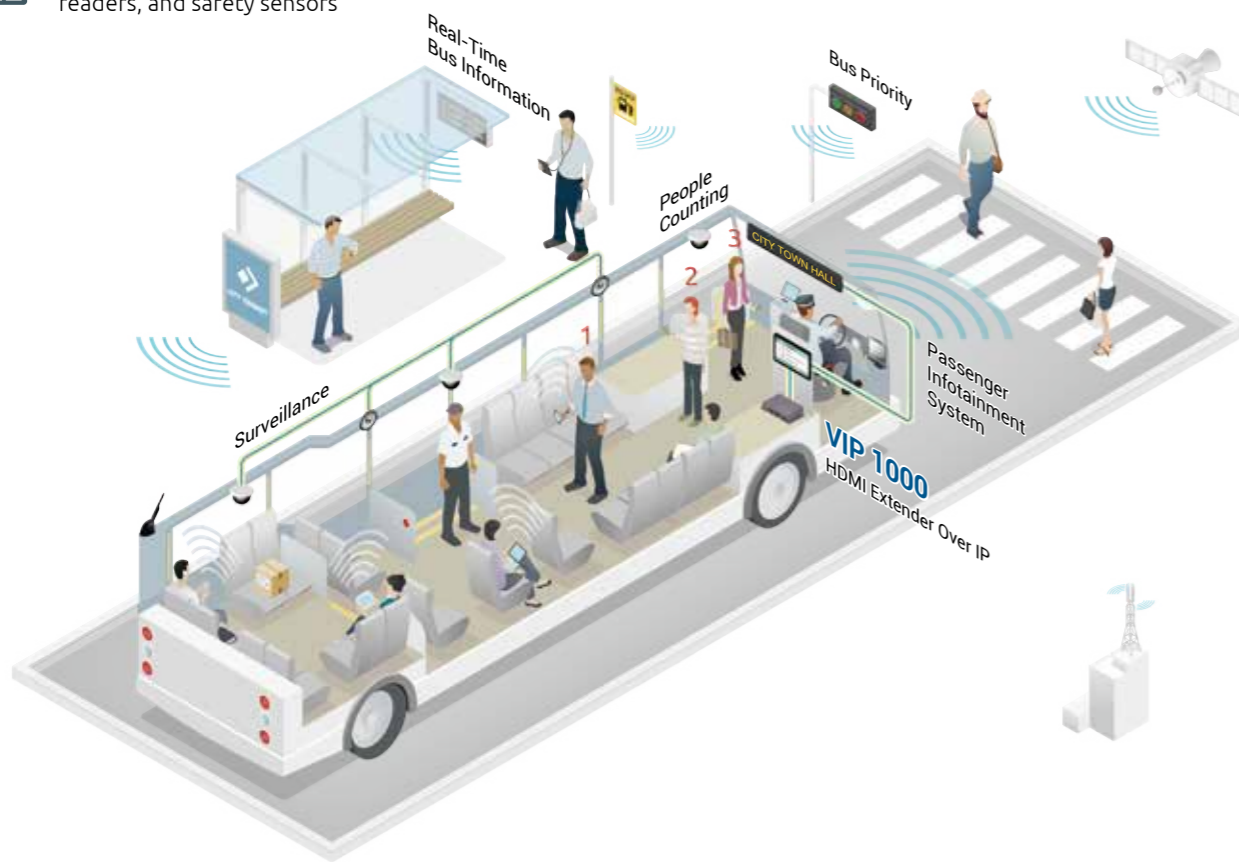

eBus Application Highlights

- IoT cloud services allow real-transmission of bus information
- Provide high-speed internet connection to improve passengers' experience
- High performance AI computing to perform pedestrian detection and collision warnings
- Obtain vehicle location even in the tunnel
- Real-time AI analysis on surveillance camera to protect passengers' safety

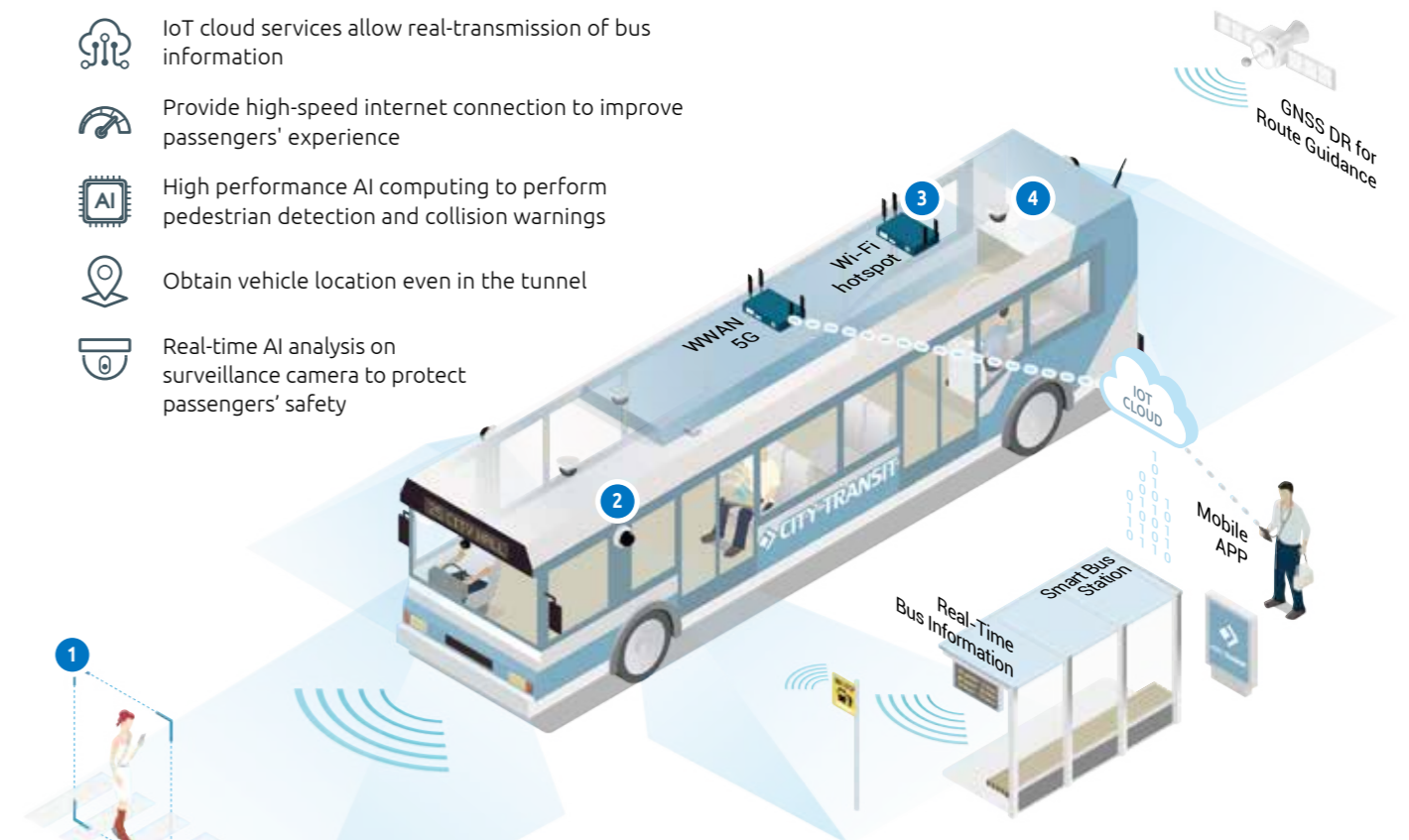

Recommended Models

VTC 1031/1031-C2
Fanless In-Vehicle Computer, Intel Atom® Elkhart Lake x6413E

- Dual display outputs and 2.5GbE LAN port
- 5G NR and Wi-Fi 6/6E wireless communication options

VIP 1000
Full HD HDMI Extender Over IP

- Plug and play
- 2 x Full HD HDMI output, up to 100 meter distance
- Unicast, daisy chain and multicast modes support

VTC 6221
Fanless In-Vehicle Computer, Intel Atom® Quad Core x7-E3950

- 3 x mini-PCIe + 2 x M.2 Key B expansion slots
- 3 x LTE/5G modules supported

VTC 7260-xC4
Fanless In-Vehicle Computer, Intel® 11th Gen Tiger Lake UP3

- 1 x LAN + 4 x independent PoE supported
- 2 x mini-PCIe + 3 x M.2 Key B/E/M expansion slots

Smart Public Rail Transit

Telematics for Transportation Security and Efficiency, Plus Passenger Satisfaction



NEXCOM's Solutions

- Compliance with regulations EN50155, EN45545-2 and MIL-STD-810H for graphics cards protection
- AI-powered platform with optional graphics card and AI accelerator
- Power isolation and protection against voltage dips
- X-coded LAN connector with PoE for IP camera for video surveillance
- HDMI extender over IP solution for PIS and infotainment

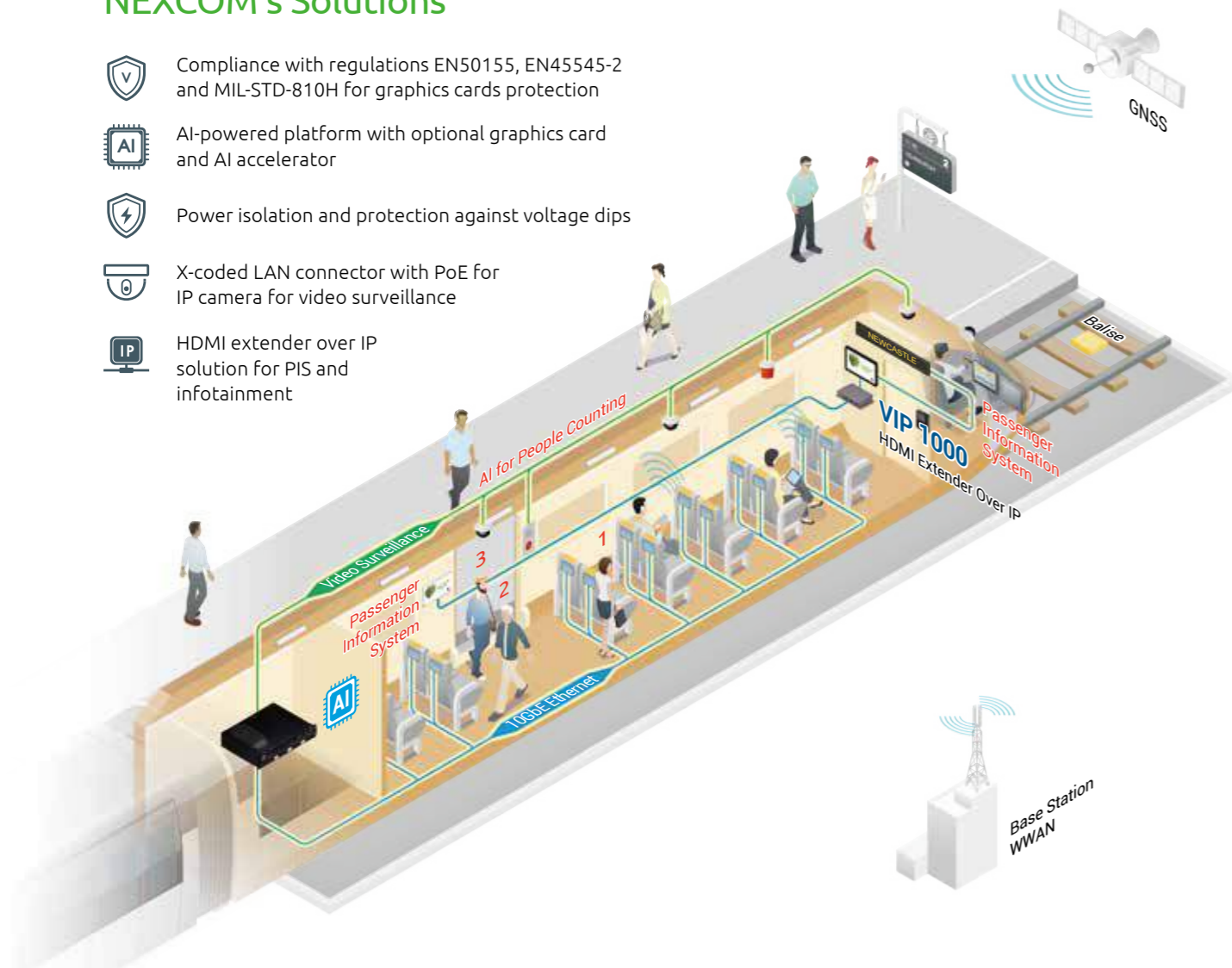

Vision Application Highlights

- Rugged design protects graphics cards against shock and vibration
- Graphics card and AI accelerator supported for edge computing
- PoE high-resolution cameras using PoE ports for video input
- Global navigation satellite system for precise and real-time location
- Multipurpose I/O connectors connect with different sensors/controllers for collecting data

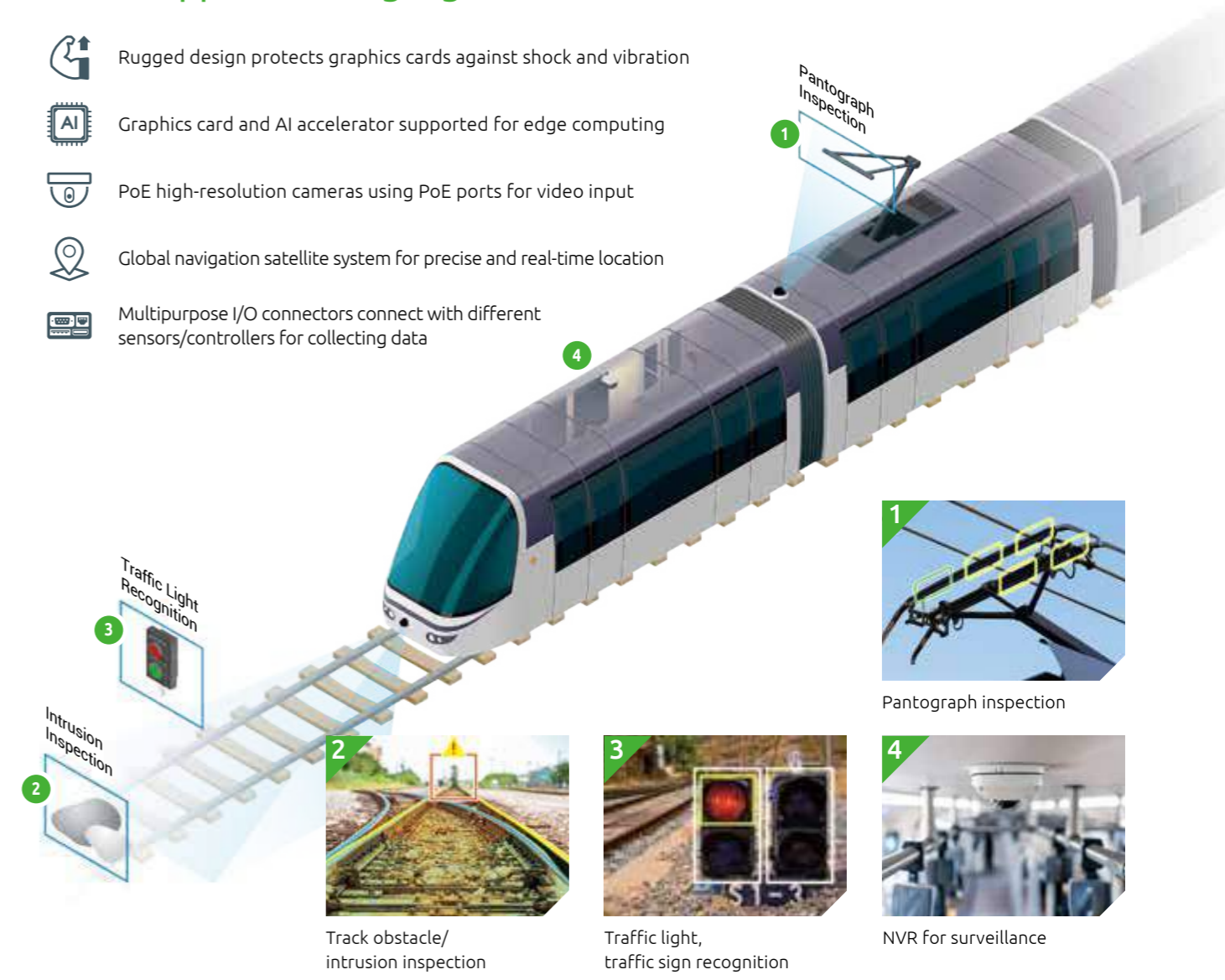

Pantograph inspection



Track obstacle/
intrusion inspection



Traffic light,
traffic sign recognition



NVR for surveillance

Recommended Models



- nROK 1031/1031-C2**
Fanless Rolling Stock Computer, Intel Atom® x6413E (Elkhart Lake)
- 5G NR and Wi-Fi 6/6E wireless communication options
 - Optional AI accelerator M.2/mini-PCIe module



- nROK 6221**
Fanless Rolling Stock Computer, Intel Atom® x7-E3950
- 3 x mini-PCIe + 2 x M.2 socket expansion
 - 3 x LTE/5G module supported



- nROK 7251-7C4**
Fanless Rolling Stock Computer, 9th Gen Intel® Core™ CPU
- 4 x Independent 10/100/1000 Mbps PoE 802.3af/at, total 60W
 - 2 x External SSD/HDD and 2 x mSATA for RAID 0, 1



- aROK 8110**
AI Powered for Autonomous and Machine Vision, Intel® Core™/Xeon® CPU
- 4 x PCIe 3.0 slots for discrete graphics/inference/frame grabber cards
 - 4 x external storage for 2.5" SSD/M.2/U.2 NVMe SSD

Public Works

Playing the Key Roles of Enriching the Community and Enhancing the Quality of Life



NEXCOM's Solutions

- Compact, Rugged, IP65/IP67 protection for reliable operation in harsh environments
- Military standard anti-vibration/shock, extended operating temperature range, -40°C to 70°C
- Combination of GNSS and WLAN/WWAN modules for tracking and massive data communication
- Street view image recognitions through AI accelerator card
- Diverse I/O ports, USB, GbE, COM, GPIO and CANBus, connect peripherals and acquire vehicle data



AI-aided Sweeper Application Highlights

- GbE PoE ports supporting IP cameras for obstacle/potholes detection
- Correcting and transmitting data to cloud for AI models re-training
- Perform Inference at the edge through AI accelerator card
- Precise and real-time vehicle location via AVL technologies
- Vibration/shock resistance and wide-range operating temperature



Recommended Models

VMC 220/2020
 8" Rugged Vehicle Mount Computer, NXP i.MX 8M Quad/Intel Atom® x7-E3950

- 1280 x 720 resolution, sunlight readable (1000 nits), PCAP touch screen
- IP65 water-resistant and IK08 external damage protection ratings

VTC 1031/1031-C2
 Fanless In-Vehicle Computer, Intel Atom® Elkhart Lake x6413E

- Dual display outputs and 2.5GbE LAN port
- 5G NR and Wi-Fi 6/6E wireless communication options

VTC 1911-IPK
 Fanless In-Vehicle Computer, Intel Atom® Single Core E3815

- Telematics IoT gateway with super slim and ruggedized design
- IP67 water- and dust-resistant rating

VTC 6220-BK
 Fanless In-Vehicle Computer, Intel Atom® Quad Core x7-E3950

- 1 x M.2 Key B & 1 x mini-PCIe for WWAN module + 2 x mini-PCIe for various applications
- Dual externally accessible 2.5" SSD trays

First Response Vehicles

Trusted Crime Fighting and Emergency Services at Any Time



NEXCOM's Solutions

- Supports up to 8 IP cameras over PoE ports (IEEE 802.3 af/at)
- CANBus 2.0B communication to read vehicle status accurately and quickly
- Supports multiple AI modules for fast facial and automatic license plate recognition (ALPR)
- Supports multiple LTE & 5G carriers for stable communication between vehicle and control center
- Backup battery ensures uninterrupted system operation

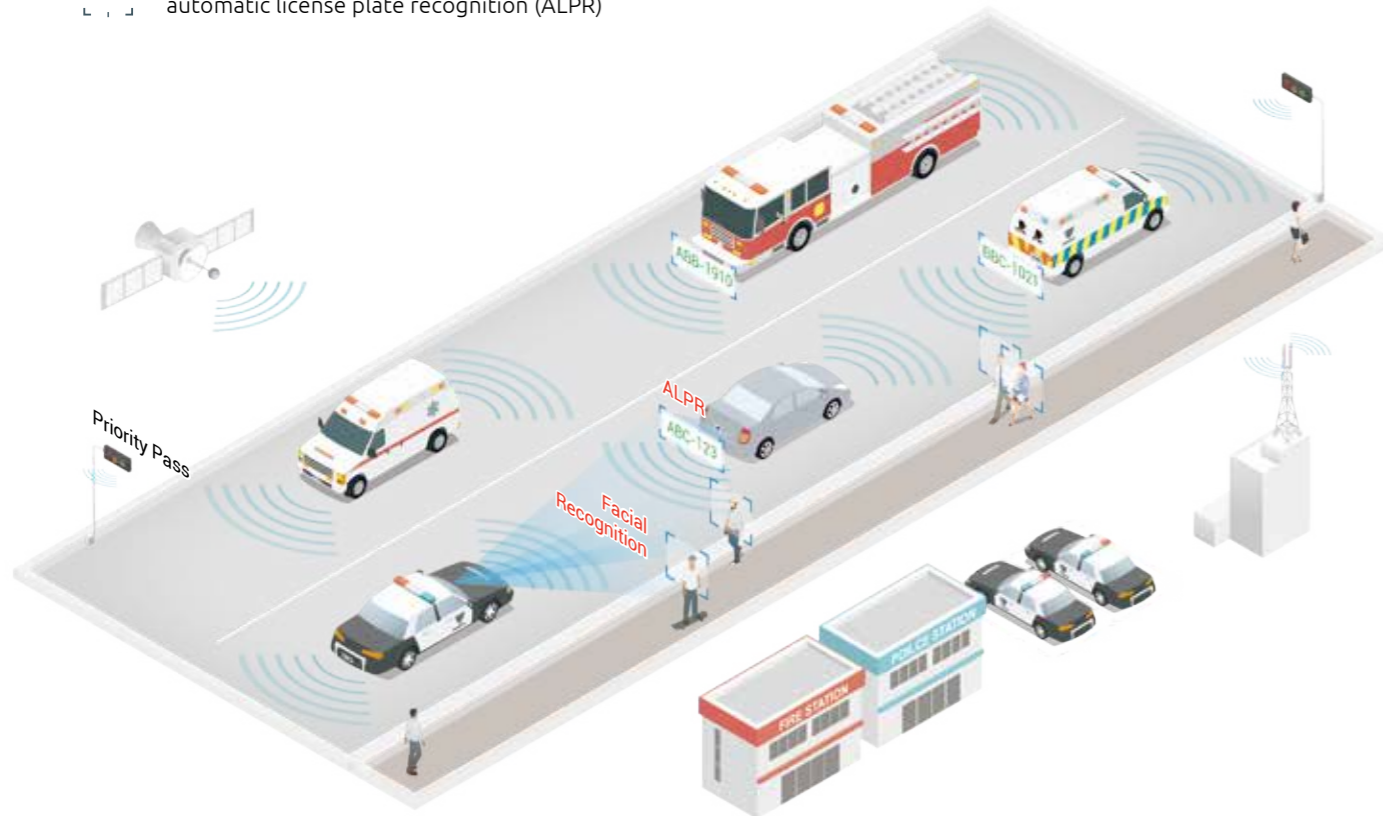

Smart AI Patrol Application Requirements Highlights

- Ability to aggregate video feeds from multiple IP cameras
- Real-time surveillance on multiple video displays
- High AI performance for sophisticated image processing (facial recognition, ALPR)
- Quick and trusted communication with emergency and control center
- Uninterrupted power supply to systems

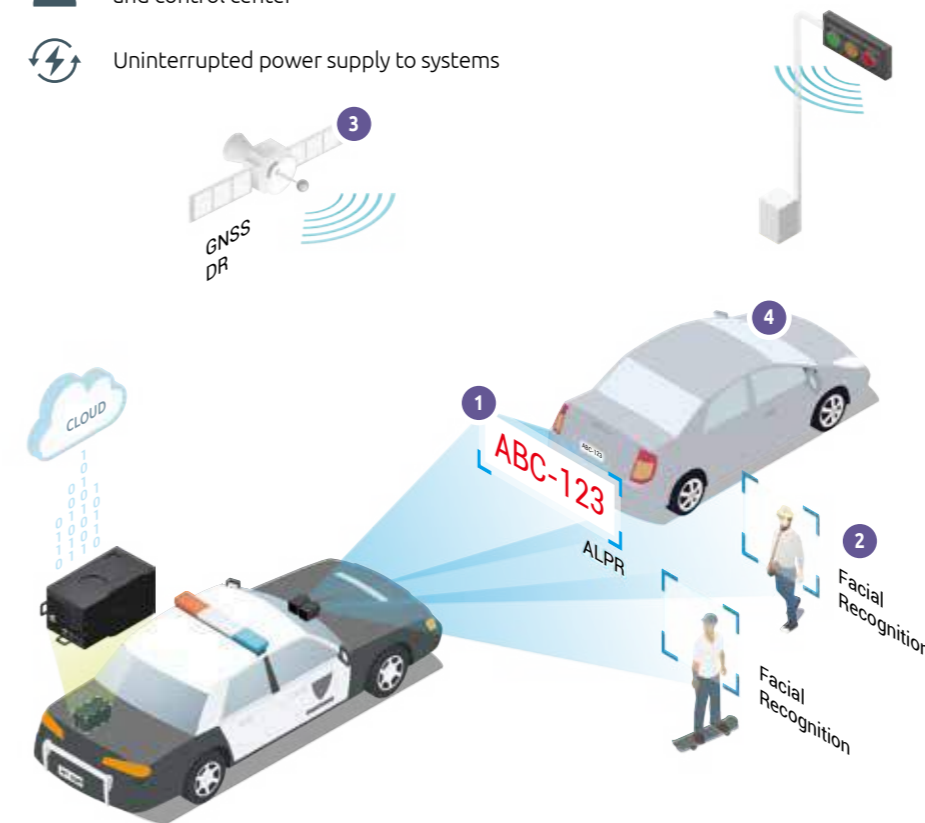

1 Support for speed violation detection and ANPR technologies



2 Facial recognition technology helps identify suspects



3 Rapid emergency dispatch and real-time monitoring



4 Driver seat belt and mobile phone use detections

Recommended Models

VTC 6222-C4S
 In-Vehicle Computer, Intel Atom® Quad Core E3950

- 1 x LAN + 4 x PoE supported
- 1 x RS232 (Full), 1 x RS232 (Tx/Rx), 1 x RS422/485

VTC 7251-7C4
 Fanless In-Vehicle Computer, Intel® Core™ i7-8700T

- 1 x LAN + 4 x independent PoE supported, total 60W
- 4 x mini-PCIe slots + 1 x M.2 Key B expansion

ATC 8010
 AI Inference, In-Vehicle, Fanless Computer with Intel® Core™ 8th Gen. CPU

- Support NVIDIA® MXM GPU (Turing and Ampere-based Quadro)
- Up to 8 independent GbE PoE+

ATC 8110
 AI Powered In-Vehicle Computer, Intel® Core™ 8th/9th CPU S/Refresh

- Add-on NVIDIA graphics card RTX30xx, 40xx series (~350W)
- MIL-STD-810H for anti-vibration/shock to protect graphics card

Port Management & Warehouse

Around-The-Clock, Reliable Delivery:
Your Trust is Our Commitment

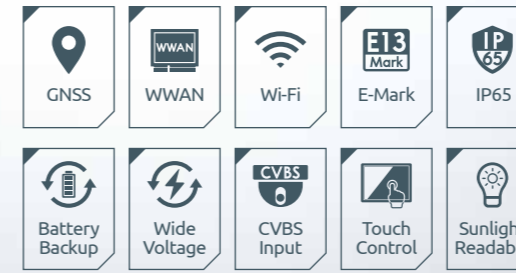

NEXCOM's Solutions

- High-brightness LCD touchscreen panel for sunlight readability
- AI-powered edge computing platform with AI accelerator
- IP65 rating ensures that it withstands extreme weather conditions
- Wide-range power input (9~60VDC) fits different vehicles' UPS batteries
- Built-in backup battery ensures protection of mission critical to operations

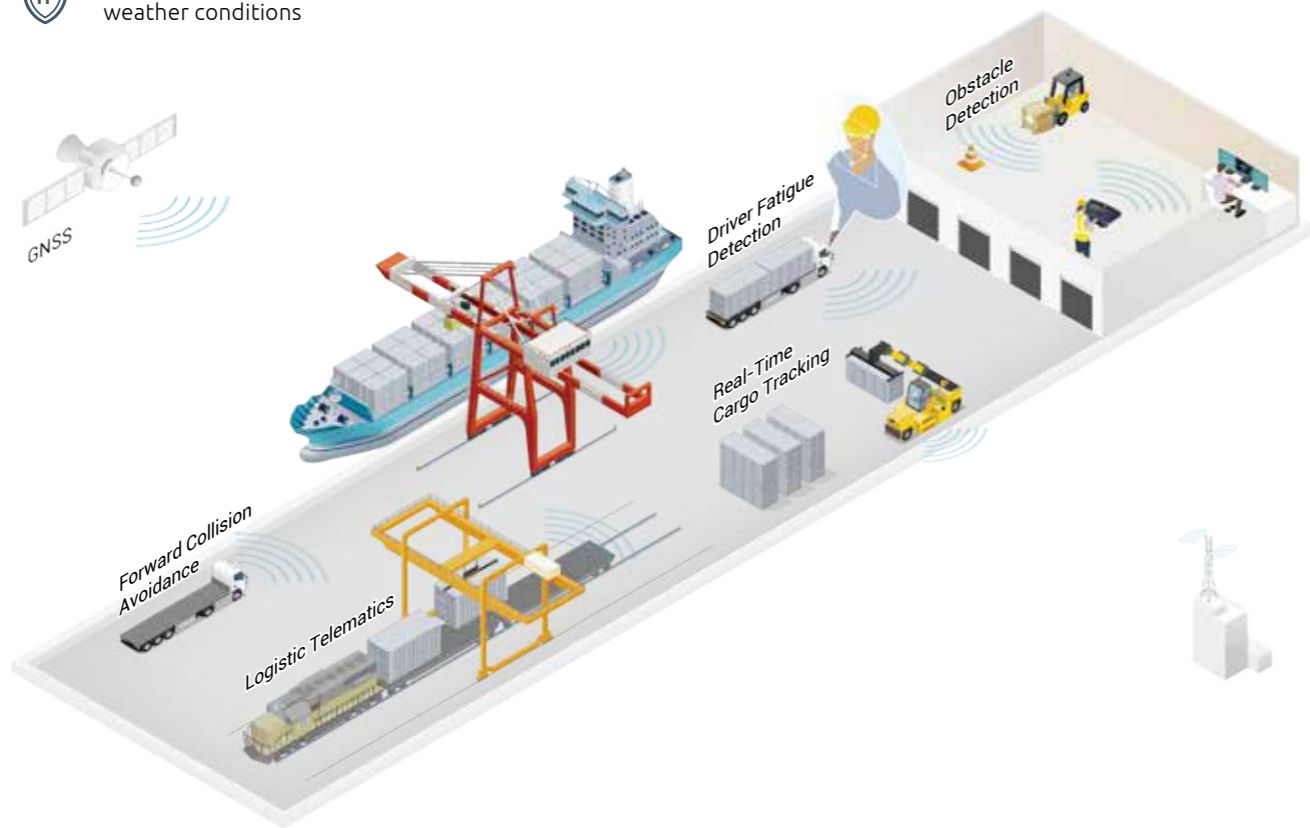

Forklift Application Highlights

- IP65 rating ensures lower risk of water/dust damaging interior electronic parts
- Sunlight readability (over 1000 nits) enhances display visibility
- Ability to aggregate video feeds from multiple cameras for AI detection
- IK08/IK09 vandal-proof rating: reduces injuries and RMA costs, while prolonging lifetime
- Backup battery for approx. 15 min. of operation when forklift battery needs to be replaced

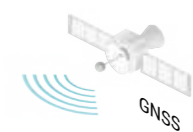

1 Surround camera for ADAS and safety



2 Uninterrupted power supply from battery



3 Sunlight readability



3 IP65 and IK08 Protection

Recommended Models



- VMC 1100**
7" All-In-One Vehicle Computer, Intel Atom® E3825
- 800 x 480 resolution, 4-wire resistive, anti-glare touch screen
 - Front panel IP54 and F1~F5 function keys



- VMC 220/2020**
8" Rugged Vehicle Mount Computer, NXP i.MX 8M Quad/Intel Atom® x7-E3950
- 1280 x 720 resolution, sunlight readable (1000 nits), PCAP touch screen
 - IP65 water-resistant and IK08 external damage protection ratings



- VMC 3020**
10.4" Rugged Vehicle Mount Computer, Intel Atom® x5-E3930
- 1024 x 768 resolution, sunlight readable (1200 nits), 5-wire resistive touch screen
 - Front panel IP65 water-resistant
 - 9V~60V DC power in



- VMC 4020**
12.1" Rugged Vehicle Mount Computer, Intel Atom® x7-E3950
- 1024 x 768 resolution, sunlight readable (1200 nits), 5-wire resistive touch screen
 - IP65 water-resistant rating (VMC 4020-4A1)
 - 9V~60V DC power in

Fleet Management

Improving Driver Safety, Saving Energy, and Increasing Overall Fleet Efficiency



NEXCOM's Solutions

- Combination of GNSS and WLAN/WWAN modules for tracking and massive data communication
- AI networks through AI accelerator to avoid car/pedestrian collisions
- USB, GbE, COM and CANBus for I/O peripherals
- Multi-SIM support for cross country route
- Extreme low/high temperature resistant, IP65/67 protection for harsh environments

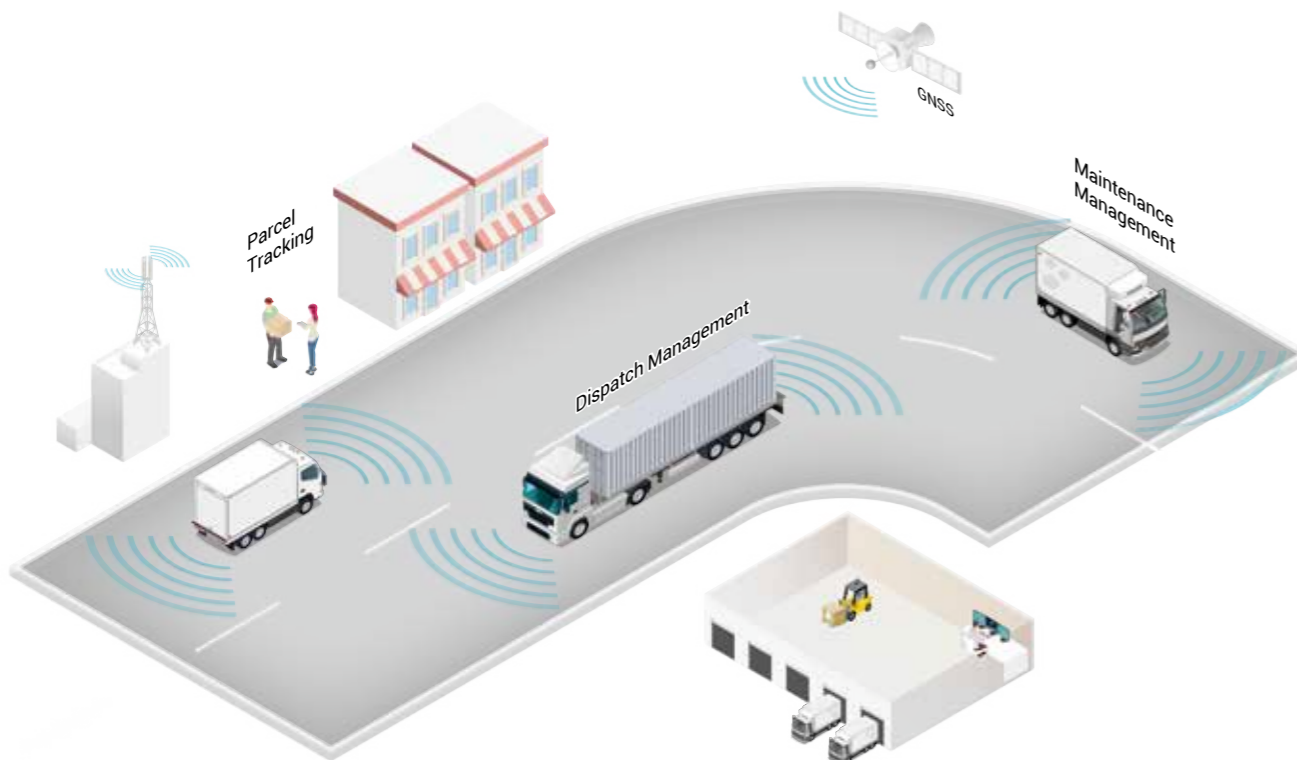

Cold Chain Logistics Application Highlights

- Real time 5G telematics connecting all vehicles and control center
- AI analysis on surrounding images to perform ADAS and protect pedestrians' safety
- GNSS/DR precise positioning to mapping vehicles location, ensure vehicles on course/scheduling
- Consistent monitoring of temperature and humidity sensors, accompanied by data uploads to the cloud
- CANBus retrieving ECU information, vehicles speed, fuel volume, etc., to improve better eco-driving



GNSS/DR guides route tracking



5G telematics for fleet communication



Cold chain monitoring



Recommended Models



VMC 220/2020

- 8" Rugged Vehicle Mount Computer, NXP i.MX 8M Quad/Intel Atom® x7-E3950
- 1280 x 720 resolution, sunlight readable (1000 nits), PCAP touch screen
 - IP65 water-resistant and IK08 external damage protection ratings



VTC 1910

- Fanless In-Vehicle Computer, Intel Atom® Single Core E3815
- Telematics IoT gateway, super slim and ruggedized design
 - Dual SIM cards for WWAN modules



VTC 1030

- Fanless In-Vehicle Computer, Intel Atom® Elkhart Lake x6211E
- Compact and fanless design
 - 5G NR and Wi-Fi 6/6E wireless communication options



VTC 1031/1031-C2

- Fanless In-Vehicle Computer, Intel Atom® Elkhart Lake x6413E
- Dual display outputs and 2.5GbE LAN port
 - 5G NR and Wi-Fi 6/6E wireless communication options

Raw Material Management

Born Tough to Increase Efficiency and Productivity

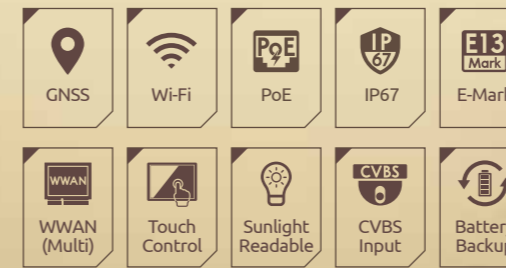

NEXCOM's Solutions

- High-brightness LCD touchscreen panel with IK08 protection
- GNSS/GPS with RTK and DR accuracy compensation for accurate vehicle positioning
- Rugged design, IP65/IP67 protection for reliable operation in harsh environments
- Rich I/O ports, USB, GbE, COM, GPIO and CANBus, connect peripherals and acquire vehicle data
- Edge AI applications, including object and driver behavior detection, prevent accidents

Mining Application Highlights

- Rugged IP65/IP67 design prevents dust and water ingress
- AI recognition to avoid car/pedestrian collisions
- GNSS RTK/DR module can track vehicles' location and prevent theft
- RFID detection can protect heavy trucks from being driven arbitrarily
- DSRC/C-V2X module can communicate among vehicles nearby, recognize signs, and predict paths; lowering collision possibilities

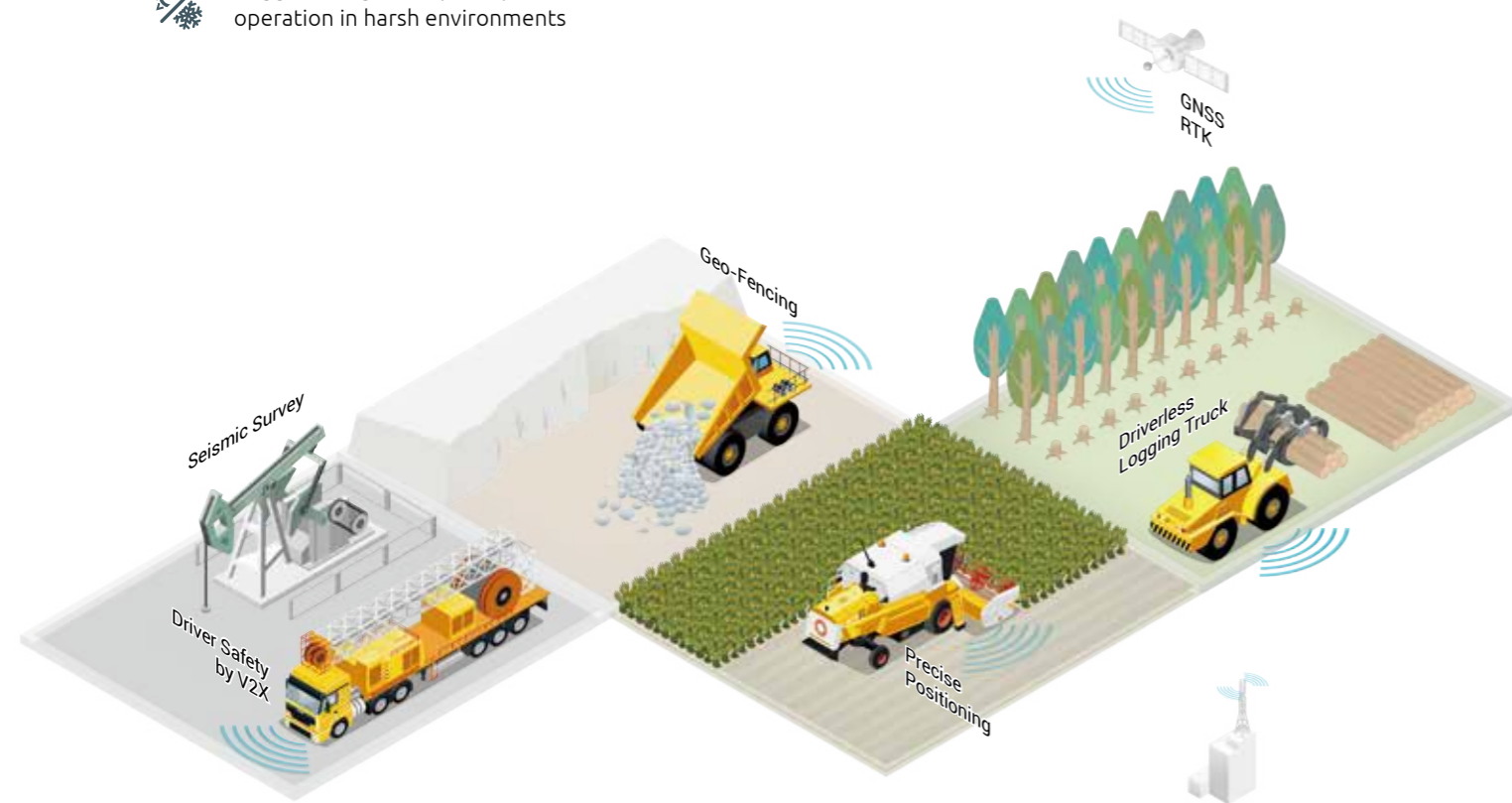

Recommended Models

VMC 220/2020
 8" Rugged Vehicle Mount Computer, NXP i.MX 8M Quad/Intel Atom® x7-E3950

- 1280 x 720 resolution, sunlight readable (1000 nits), PCAP touch screen
- IP65 water-resistant and IK08 external damage protection ratings

ATC 3530/3540
 IP 67 Accelerated Edge AI In-Vehicle Computer with built-in NVIDIA® Jetson Xavier™ NX/Orin™ NX SOM

- Supports 4-CH MIPI SerDes (VBO)/cameras (up to 25m cable reach)/4-ch PoE
- Supports LTE/5G and Wi-Fi 6/6E

VTC 1031/1031-C2
 Fanless In-Vehicle Computer, Intel Atom® Elkhart Lake x6413E

- Dual display outputs and 2.5GbE LAN port
- 5G NR and Wi-Fi 6/6E wireless communication options

VTC 7252-7C4IP
 Fanless In-Vehicle Computer, Intel® Core™ i7-9700TE

- 2 x LAN + 4 x independent PoE supported
- IP65 water and dust-resistant rating

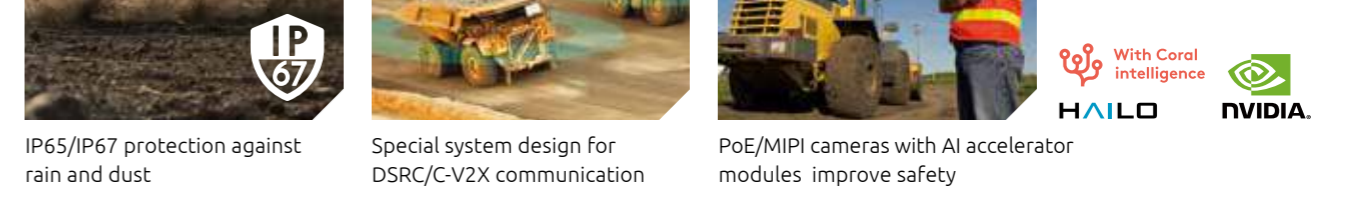

2023 New Products



ATC 3540/3520-IP7-4C/AI4CR

IP67 Accelerated Edge AI In-vehicle/Railway Computer

- Built-in NVIDIA® Jetson Orin™ NX SOM, up to 100 TOPS (INT8)
- Support 4-port GbE PoE
- HEVC/H.265 hardware DECODE@ 18 x 1080p30 performance
- Ultra-speed PCIe 3.0 x4 NVMe SSD, LTE/5G modem & Wi-Fi 5/6 expansion
- Operating temperature of -30~70°C



ATC 3750-6C/3750-A6CR

Accelerated Edge AI In-vehicle/Railway Computer

- Built-in NVIDIA® Jetson AGX Orin™ SOM, up to 200/275 TOPS (INT8) performance
- Designed with rugged, compact and hybrid thermal solutions
- 6-port GbE PoE+ for IP CAM/LiDAR sensors, optional 1-port 10GbE
- HEVC/H.265 hardware DECODE@ 6 x 4K30 performance
- E Mark and EN50155



VTC 1030

Fanless In-vehicle/Rolling Stock Computer

- Intel Atom® x6211E (Elkhart Lake) Dual Core processor, 6W
- Compact and fanless design with E Mark certification
- 5G NR and Wi-Fi 6/6E wireless communication options
- Built-in GNSS receiver
- Dual display outputs and 2.5GbE LAN ports



nROK 1030-A

Fanless Rolling Stock Computer

- Intel Atom® x6211E (Elkhart Lake) Dual Core processor, 6W
- Compact and fanless design with EN45545 and EN50155 certification
- 5G NR and Wi-Fi 6/6E wireless communication options
- Built-in GNSS receiver
- Dual display outputs and 2.5GbE LAN ports



VTC 1031/1031-C2

Fanless In-vehicle Telematics Computer

- Intel Atom® x6413E (Elkhart Lake) Quad Core processor, 9W
- Dual display outputs and 2.5GbE LAN port
- 5G NR and Wi-Fi 6/6E wireless communication options
- 2 x PoE support, total 60W (VTC 1031-C2)
- Optional equipped AI accelerator M.2/mini-PCIe module



nROK 1031-A/1031-AC2

Fanless Rolling Stock Telematics Computer

- Intel Atom® x6413E (Elkhart Lake) Quad Core processor, 9W
- 5G NR and Wi-Fi 6/6E wireless communication options
- Dual display outputs and 2.5GbE LAN M12 X-coded port
- 2 x PoE support, total 60W (nROK 1031-AC2)
- Optional equipped AI accelerator M.2/mini-PCIe module



VTC 7260-x/7260-xC4

Fanless AI Power Vehicle Computer

- 11th Gen Intel® Core™ i5-1145GRE/Core™ i7-1185GRE (Tiger Lake UP3)
- Compact, rugged and fanless design
- Rich I/Os, 4 x 2.5GbE PoE+ (VTC 7260-5C4/7C4), 3 x LAN (VTC 7260-5/7), 4 x USB 3.2/2.0 & 2 x RS232/422/485
- 1 x 2.5" SSD, 1 x mSATA and 1 x NVMe SSD for data integrity
- Up to 3 combinations of LTE/5G, Wi-Fi 5/6 for mobile router function



VTC 7270/7270-C4/7270-C8

Fanless AI Powered Vehicle Computer

- Powered by 12/13th Gen Intel® Core™ i with DDR5, excellent memory bandwidth, lower latency
- Rich I/Os, 4/8 x 2.5 GbE PoE+ (VTC 7270-C4/C8), 3 x LAN (VTC 7270), 6 x USB 3.2, 2 x CAN FD & 4 x Serials
- 2 x 2.5" SSD, 1 x NVMe ultra-speed SSD for data integrity
- Support 4 x 2.5GbE PoE+ (VTC 7270-C4) and ,8 x 2.5GbE PoE+ (VTC 7270-C8)



VES31-4S/-8S & VES31-4SR/-8SR

Unmanaged Gigabit Ethernet Switch with 4-port/8-port PoE

- 4/8 x 10/100/1000 Mbps PoE port (802.3af/at compliance)
- Smart power management with ignition control and power on/off delay
- Wide power input range 9 ~ 36VDC
- -40 ~ 70°C operating temperature
- E mark and EN50155 for in-vehicle and railway applications



VIP 1000-T/1000-R

Full HD HDMI Extender Over IP

- Plug and play
- 2 x Full HD HDMI output, up to 100 meter distance
- Unicast, daisy chain and multicast modes support
- Wide-range 9-36VDC input voltage with ignition control
- E mark for in-vehicle application



Industrial Edge AI Telematics Computer



ATC/aROK Series Brief Product Introduction

Product Description

AI has become an essential component of automated vehicle technologies. With built-in state of the art AI accelerator, ATC and aROK series are expertise for edge AI in-vehicle/railway applications. Besides, ATC/

aROK features with extreme wide-range operating temperature, military standard anti-vibration/shock and dust/water proof IP67 rating making it constantly perform 100% workload in harsh environments.

-  NVIDIA® Jetson SOM, Quadro MXM/PCIe x16 AI accelerator support
-  5G/LTE, Wi-Fi 6/6E, BT, PoE, CAN function support

-  EN50155 & E-Mark certification
-  Optional railway isolated power input

Application

ATC: ADAS, ANPR, AMR, autonomous driving

aROK: Pantograph inspection, track obstacle inspection, traffic sign recognition

Product Highlight



Edge AI, inference accelerator



Sturdy system with securing cards/SOM for OHV and train



Strong ingress protection, IP65/IP67



MIPI SerDes solution support



aROK 5510







aROK 8110

Model	aROK 5510	aROK 8110
System		
CPU	Intel® Coffee Lake S/ Refresh Core™/Xeon®	Intel® Coffee Lake S/ Refresh Core™/Xeon®
Chipset	Intel® C246	Intel® C246
Fan/Fanless	Fan (fan-kit pre-installed)	Fan (fan-kit pre-installed)
Memory	4 x DDR4 2666 SO-DIMM, up to 32GB + 32GB + 32GB + 32GB	2 x DDR4 2666 SO-DIMM, up to 32GB + 32GB
Storage	6 x 2.5" SATA SSD (removable, 9.5mm)	4 x 2.5" SATA 3.0 SSD/HDD (15mm height), or 3 x 2.5" SATA 3.0 SSD/HDD + 2 x M.2 2280/2242/2260 Key M NVMe SSD (PCIe 3.0 x2), or 3 x 2.5" SATA 3.0 SSD/HDD + 1 x U.2 NVMe SSD (PCIe 3.0 x2)
Second Storage	1 x mSATA, 1 x M.2 2280/2242/2260 Key M NVMe SSD (PCIe 3.0 x4), 1 x Removable SD 3.0	1 x CFast (external accessible)
GPU/VP/TPU Coprocessor	One PCIe 3.0 x16 lane for optional NVIDIA Graphics card (100W)	One PCIe 3.0 x16 lane for optional NVIDIA Graphics card
Video Out	1 x VGA, 1 x HDMI	1 x VGA, 1 x HDMI
Audio	1 x Mic-in, 2 x Line-out	1 x Mic-in, 1 x Line-out
Ethernet	2 x Intel® 10/100/1000 (M12), 2 x 10GbE SFP+ card (optional)	2 x Intel® 10/100/1000 (M12)
PoE	4 x M12 GbE independent (802.3at/af), Total 60W (optional)	Up to 3 x GEM640 card (optional), each card with 4 x M12 Intel® GbE (w/ 802.3at/af), Total 60W+60W+60W
I/O Interface		
USB	1 x M12 with 2 x USB 2.0 signal, 3 x USB 3.2 (Gen2), 1 x USB 3.2 (Gen1)	1 x M12 with 2 x USB 2.0 signal, 3 x USB 3.2 (Gen2), 1 x USB 2.0
COM	2 x RS-232 (Full), 1 x RS232 (Full)/422/485. (w/ isolation)	4 x RS232 (Full)/422/485. (w/ isolation)
DIO	4 x DI, 4 x DO (w/ isolation)	4 x DI, 4 x DO (w/ isolation)
CAN Bus	1 x CAN Bus 2.0B (w/ isolation)	1 x CAN Bus 2.0B (w/ isolation)
SIM Socket	8 (BOM option up to 10, eSIM BOM optional)	4 (eSIM BOM optional)
DC Output	N/A	N/A
MIPI Interface	N/A	N/A
WWAN	4 (BOM option up to 5)	2
Expansion		
mini-PCIe Socket	- 1 x (USB 2.0, PCIe 3.0) - 1 x (USB 2.0, PCIe 3.0). BOM option to 1 x mini-PCIe (USB 2.0) for LTE - 1 x (USB 2.0) for LTE. BOM option to 1 x M.2 3042/3050/3052 Key B (USB 2.0, USB 3.2 (Gen1)) for LTE/5G.	- 1 x (USB 2.0, PCIe 2.0) 1 x (USB 2.0) for LTE. BOM option to 1 x M.2 3042 Key B (USB 2.0) for LTE
M.2 Socket	3 x M.2 3042/3050/3052 Key B (USB 2.0, USB 3.2 (Gen2)) for LTE/5G	1 x M.2 3042/3050/3052 Key B (USB 2.0, USB 3.2 (Gen2)) for LTE/5G
Expansion PCIe Slot	PCIe x16	1 x PCIe x16, 3 x PCIe x4
GNSS	VIOB-GPS-02 module (u-blox NEO-M8N)	VIOB-GPS-02 module (u-blox NEO-M8N)
Power Input	DC 24/110V (w/ isolation)	DC 24/36V (w/o isolation)
Environment		
Ingress Protection	N/A	N/A
Certification	CE, FCC Class A, UKCA, EN50155	CE, FCC Class A, UKCA, EN50155
Operating Temperature	-40°C to 70°C (OT4)	-40°C to 70°C (OT4)
TPM	TPM 2.0	TPM 2.0
Others		
OS	Win 10/11, Linux (Kernel 4.x)	Win 10/11, Linux (Kernel 4.x)
Dimensions (mm)	483 x 400 x 95	215 x 205 x 385





Industrial Edge AI Telematics Computer

Model				
	ATC 8010	ATC 8010-F	ATC 8110	ATC 8110-F
System				
CPU	Intel® Coffee Lake S/ Refresh Core™/Xeon®	Intel® Coffee Lake S/Refresh Core™/Xeon®	Intel® Coffee Lake S/ Refresh Core™/Xeon®	Intel® Coffee Lake S/ Refresh Core™/Xeon®
Chipset	Intel® Q370	Intel® Q370	Intel® C246	Intel® C246
Fan/Fanless	Fanless	Fan (fan-kit pre-installed)	Fanless	Fan (fan-kit pre-installed)
Memory	2 x DDR4 2400/2666 SO-DIMM, up to 32GB + 32GB	2 x DDR4 2400/2666 SO-DIMM, up to 32GB + 32GB	2 x DDR4 2400/2666 SO-DIMM, up to 32GB + 32GB	2 x DDR4 2400/2666 SO-DIMM, up to 32GB + 32GB
Storage	2 x 2.5" SATA 3.0 SSD (removable, 15mm)	2 x 2.5" SATA 3.0 SSD (removable, 15mm)	3 x 2.5" SATA 3.0 SSD/HDD (removable, 15mm) or 2 x 2.5" SATA 3.0 SSD/HDD + 1 x 2.5" U.2/NVMe M.2 2280	3 x 2.5" SATA 3.0 SSD/HDD (removable, 15mm) or 2 x 2.5" SATA 3.0 SSD/HDD + 1 x 2.5" U.2/NVMe M.2 2280
Second Storage	2 x mSATA (occupied mini-PCIe socket)	2 x mSATA (occupied mini-PCIe socket)	1 x CFast (external accessible)	1 x CFast (external accessible)
GPU/VP/TPU Coprocessor	NVIDIA Quadro® MXM module (RTX A1000/RTX A2000)	NVIDIA Quadro® MXM module, Quadro (RTX A4500)	One 3-slot width PCIe 3.0 x16 lane for optional NVIDIA Graphics card	One 3-slot width PCIe 3.0 x16 lane for optional NVIDIA Graphics card
Video Out	1 x VGA, * 5 x HDMI, 1 x ultraONE+	1 x VGA, * 5 x HDMI, 1 x ultraONE+	1 x VGA, 1 x HDMI	1 x VGA, 1 x HDMI
Audio	1 x Mic-in, 1 x Line-out	1 x Mic-in, 1 x Line-out	1 x Mic-in, 1 x Line-out	2 x Mic-in, 2 x Line-out
Ethernet	1 x Intel® 10/100/1000	1 x Intel® 10/100/1000	2 x Intel® 10/100/1000	2 x Intel® 10/100/1000
PoE	8 x Independent Intel® 10/100/1000 (w/ 802.3at/af). Total 60W	8 x Independent Intel® 10/100/1000 (w/ 802.3at/af). Total 60W	N/A	N/A
USB	6 x USB 3.2 (Gen2)	6 x USB 3.2 (Gen2)	5 x USB 3.2 (Gen2), 1 x USB2.0	5 x USB 3.2 (Gen2), 1 x USB2.0
COM	2 x RS232 (Full), 1 x RS232 (Full)/422/485	2 x RS232 (Full), 1 x RS232 (Full)/422/485	4 x RS232 (Full)/422/485	4 x RS232 (Full)/422/485
DIO	4 x DI, 4 x DO	4 x DI, 4 x DO	4 x DI (w/ isolation) 4 x DO (w/ isolation)	4 x DI (w/ isolation) 4 x DO (w/ isolation)
CAN Bus	1 x CAN Bus 2.0B (w/ isolation)	1 x CAN Bus 2.0B (w/ isolation)	1 x CAN Bus 2.0B (w/ isolation)	1 x CAN Bus 2.0B (w/ isolation)
SIM Socket	3 (eSIM BOM optional)	3 (eSIM BOM optional)	4 (eSIM BOM optional)	4 (eSIM BOM optional)
DC Output	12V (2A)	12V (2A)	12V (2A)	12V (2A)
MIPI Interface	N/A	N/A	N/A	N/A
WWAN	2	2	2	2
mini-PCIe Socket	- 1 x (USB 2.0) for LTE - 1 x (USB 2.0, PCIe 3.0/SATA 3.0) - 1 x (USB 2.0, PCIe 3.0/SATA 3.0)	- 1 x (USB 2.0) for LTE - 1 x (USB 2.0, PCIe 3.0/SATA 3.0) - 1 x (USB 2.0, PCIe 3.0/SATA 3.0)	- 1 x (USB 2.0) for LTE - 1 x (USB 2.0, PCIe 2.0)	- 1 x (USB 2.0) for LTE - 1 x (USB 2.0, PCIe 2.0)
M.2 Socket	1 x M.2 3042 Key B (USB 2.0, USB 3.2 (Gen1)) for LTE/5G	1 x M.2 3042 Key B (USB 2.0, USB 3.2 (Gen1)) for LTE/5G	1 x M.2 3042/3052 Key B (USB 2.0, USB 3.2 (Gen1)) for LTE/5G	1 x M.2 3042/3052 Key B (USB 2.0, USB 3.2 (Gen1)) for LTE/5G
Expansion PCIe Slot	N/A	N/A	1 x PCIe x16, 1 x PCIe x4 + proprietary, 1 x PCIe x4	1 x PCIe x16, 1 x PCIe x4 + proprietary, 1 x PCIe x4
GNSS	VIOB-GPS-02 module (u-blox NEO-M8N)	VIOB-GPS-02 module (u-blox NEO-M8N)	VIOB-GPS-02 module (u-blox NEO-M8N)	VIOB-GPS-02 module (u-blox NEO-M8N)
Power Input	DC 9V to 36V	DC 9V to 36V	DC 9V to 36V	DC 9V to 36V
Environment				
Ingress Protection	N/A	N/A	N/A	N/A
Certification	CE, FCC Class A, UKCA, E13	CE, FCC Class A, UKCA, E13	CE, FCC Class A, UKCA, E13	CE, FCC Class A, UKCA, E13
Operating Temperature	-30°C to 60°C	-30°C to 60°C	-30°C to 60°C	-30°C to 60°C
TPM	TPM 2.0	TPM 2.0	TPM 2.0	TPM 2.0
Others				
OS	Win 10/11, Linux (Kernel 4.x)	Win 10/11, Linux (Kernel 4.x)	Win 10/11, Linux (Kernel 4.x)	Win 10/11, Linux (Kernel 4.x)
Dimensions (mm)	260 x 259.7 x 90.1	260 x 259.7 x 99 (w/ fan kit)	191.2 x 176 x 350	207.4 x 176 x 350 (w/ fan kit)



Based on different MXM for ATC 8010 and ATC 8010-F, the quantity will be different.

Product appearance and specifications are subject to change without notice.

Model			
	ATC 3200	ATC 3530-IP7-4M	ATC 3530-IP7-4C
System			
CPU	NVIDIA® Tegra X2 2 Core NVIDIA Denver2 and 4 Core ARM A57	NVIDIA® Jetson Xavier™ NX 3 x 2-core Carmel CPU@1.9GHz	NVIDIA® Jetson Xavier™ NX 3 x 2-core Carmel CPU@1.9GHz
Chipset	N/A	N/A	N/A
Fan/Fanless	Fanless	Fanless	Fanless
Memory	Onboard LPDDR4 1600MHz, 8GB, 59.7GB/s	Onboard 128-bit LPDDR4, 8GB/16GB, 59.7GB/s	Onboard 128-bit LPDDR4, 8GB/16GB, 59.7GB/s
Storage	32GB eMMC 5.1	16GB eMMC 5.1	16GB eMMC 5.1
Second Storage	1 x Removable microSD 1 x 2.5" SATA 3.0 SSD (15mm height)	1 x Removable microSD 1 x M.2 2280 Key M NVMe SSD (PCIe 3.0 x4)	1 x Removable microSD 1 x M.2 2280 Key M NVMe SSD (PCIe 3.0 x4)
GPU/VP/TPU Coprocessor	NVIDIA Pascal 256-core integrated GPU @1.2GHz	NVIDIA Volta 384-core, 48 Tensor-core integrated GPU @1.1GHz	NVIDIA Volta 384-core, 48 Tensor-core integrated GPU @1.1GHz
Video Out	1 x HDMI	1 x HDMI	1 x HDMI
Audio	1 x Mic-in, 1 x Line-out	N/A	N/A
Ethernet	N/A	2 x Intel® 10/100/1000 (M12 X-coded)	1 x Intel® 10/100/1000 (M12 X-coded)
PoE	2 x Independent Intel® 10/100/1000 (802.3af/at). Total 30W	Option for PoE (w/ 802.3af/at). Total 30W	4 x GbE M12 X-coded (802.3af/at). Total 30W
USB	2 x USB 3.2 (Gen1), 1 x USB 2.0, 1 x OTG	2 x USB 3.2 (Gen1), 1 x OTG	2 x USB 3.2 (Gen1), 1 x OTG
COM	2 x RS232 (Tx, Rx)/ 422/485, 1 x Console	1 x RS232 (Tx, Rx), 1 x RS232 (Tx, Rx, RTS, CTS), 1 x Console	1 x RS232 (Tx, Rx), 1 x RS232 (Tx, Rx, RTS, CTS), 1 x Console
DIO	4 x DI (w/ isolation) 4 x DO (w/ isolation)	4 x DI 4 x DO	4 x DI 4 x DO
CAN Bus	1 x CAN Bus 2.0B (w/ isolation)	1 x CAN Bus 2.0B (w/ isolation)	1 x CAN Bus 2.0B (w/ isolation)
SIM Socket	2	2	2
DC Output	12V(2A) & 5V(1A)	N/A	N/A
MIPI Interface	4 (V-by-One HS)	4 (Thine, V-by-One HS)	N/A
WWAN	1	1	1
mini-PCIe Socket	1 x (USB 2.0, PCIe 2.0)	1 x (USB 2.0, PCIe 3.0)	1 x (USB 2.0, PCIe 3.0)
M.2 Socket	1 x M.2 3042/3052 Key B (USB 2.0, USB 3.2 (Gen1)) for LTE/5G	1 x M.2 3042/3052 Key B (USB 2.0, USB 3.2 (Gen1)) for LTE/5G	1 x M.2 3042/3052 Key B (USB 2.0, USB 3.2 (Gen1)) for LTE/5G
Expansion PCIe Slot	N/A	N/A	N/A
GNSS	VIOB-GPS-02 module (u-blox NEO-M8N)	VIOB-GPS-02 module (u-blox NEO-M8N)	VIOB-GPS-02 module (u-blox NEO-M8N)
Power Input	DC 9V to 36V	DC 9V to 36V	DC 9V to 36V
Environment			
Ingress Protection	IP50	IP67	IP67
Certification	CE, FCC Class A, UKCA, E13	CE, FCC Class A, UKCA, E13	CE, FCC Class A, UKCA, E13
Operating Temperature	-30°C to 70°C	-30°C to 70°C (SoM @10W TDP, w/ 30W PoE PSE)	-30°C to 70°C (SoM @10W TDP, w/ 30W PoE PSE)
TPM	N/A	N/A	N/A
Others			
OS	JetPack 4.4 BSP w/ Ubuntu 18.04 (L4T)	BSP w/ JetPack 4.6, Ubuntu 18.04 @Kernel 4.9.140	BSP w/ JetPack 4.6, Ubuntu 18.04 @kernel 4.9.140
Dimensions (mm)	180 x 156 x 60	213 x 167 x 82.8	213.0 x 167.0 x 82.8







Product appearance and specifications are subject to change without notice.





Industrial Edge AI Telematics Computer

Industrial Edge AI Telematics Computer

Industrial Edge AI Telematics Computer

Model					
	ATC 3540-IP7-4C	ATC3540-IP7-AI4CR (Rail)	ATC 3750-6C	ATC 3750-A6CR (Rail)	ATC 3750-IP7-8M
System	<p>CPU: NVIDIA® Jetson Orin™ NX 6-core/8-core Carmel CPU@2.0GHz</p> <p>Chipset: N/A</p> <p>Fan/Fanless: Fanless</p> <p>Memory: Onboard 128-bit LPDDR5, 8GB/16GB, 102GB/s</p> <p>Storage: N/A</p> <p>Second Storage: 1 x M.2 2280 Key M NVMe SSD (PCIe 4.0 x4)</p> <p>GPU/VPU/TPU Coprocessor: NVIDIA Ampere 1024-core, 32 Tensor-core integrated GPU @918MHz</p> <p>Video Out: 1 x HDMI</p> <p>Audio: N/A</p>				
I/O Interface	<p>Ethernet: 1 x Intel® 10/100/1000 (M12 X-coded)</p> <p>PoE: 4 x GbE M12 X-coded (802.3at/af). Total 30W</p> <p>USB: 2 x USB 3.2 (Gen1), 1 x OTG</p> <p>COM: 1 x RS232 (Tx, Rx), 1 x RS232 (Tx, Rx, RTS, CTS), 1 x Console</p> <p>DIO: 4 x DI, 4 x DO</p> <p>CAN Bus: 1 x CAN Bus 2.0B (w/ isolation)</p> <p>SIM Socket: 2</p> <p>DC Output: N/A</p> <p>MIPI Interface: N/A</p> <p>WWAN: 1</p> <p>mini-PCIe Socket: 1 x (USB 2.0, PCIe 4.0)</p>				
Expansion	<p>M.2 Socket: - 1 x M.2 3042/3052 Key B (USB 2.0, USB 3.2 (Gen1)) for LTE/5G</p> <p>Expansion PCIe Slot: N/A</p> <p>GNSS: VIOB-GPS-06 module (u-blox NEO-M9N)</p> <p>Power Input: DC 9V to 36V</p>				
Environment	<p>Ingress Protection: IP67</p> <p>Certification: CE, FCC Class A, UKCA, E13</p> <p>Operating Temperature: -30°C to 70°C (SoM @10W~25W TDP, w/ 30W PoE PSE)</p> <p>TPM: N/A</p> <p>OS: BSP w/ JetPack 5.1.1, Ubuntu 20.04 @kernel 5.10</p>				
Others	<p>Dimensions (mm): 213.0 x 167.0 x 82.8</p>				



Model				
	ATC 3520-IP7-4C	ATC3520-IP7-AI4CR (Rail)	ATC 3520-IP7-3M	ATC 3540-IP7-3M
System	<p>CPU: NVIDIA® Jetson Orin™ Nano 6-core Arm® Cortex®-A78AE 64-bit</p> <p>Chipset: N/A</p> <p>Fan/Fanless: Fanless</p> <p>Memory: Onboard 4GB/8GB 64-bit/128-bit LPDDR5, 2133MHz</p> <p>Storage: N/A</p> <p>Second Storage: 1 x M.2 2280 Key M NVMe SSD (PCIe 4.0 x4)</p> <p>GPU/VPU/TPU Coprocessor: NVIDIA Ampere 512/1024-core, 16/32 Tensor-core integrated GPU @625MHz</p> <p>Video Out: 1 x HDMI</p> <p>Audio: N/A</p>			
I/O Interface	<p>Ethernet: 1 x Intel® 10/100/1000 (M12 X-coded)</p> <p>PoE: 4 x GbE M12 X-coded (802.3at/af). Total 30W</p> <p>USB: 2 x USB 3.2 (Gen1), 1 x OTG</p> <p>COM: 1 x RS232 (Tx, Rx), 1 x RS232 (Tx, Rx, RTS, CTS), 1 x Console</p> <p>DIO: 4 x DI, 4 x DO</p> <p>CAN Bus: 1 x CAN Bus 2.0B (w/ isolation)</p> <p>SIM Socket: 2</p> <p>DC Output: N/A</p> <p>MIPI Interface: N/A</p> <p>WWAN: 1</p> <p>mini-PCIe Socket: 1 x (USB 2.0, PCIe 4.0)</p>			
Expansion	<p>M.2 Socket: - 1 x M.2 3042/3052 Key B (USB 2.0, USB 3.2 (Gen1)) for LTE/5G</p> <p>Expansion PCIe Slot: N/A</p> <p>GNSS: VIOB-GPS-06 module (u-blox NEO-M9N)</p> <p>Power Input: DC 9V to 36V</p>			
Environment	<p>Ingress Protection: IP67</p> <p>Certification: CE, FCC Class A, UKCA, E13</p> <p>Operating Temperature: -30°C to 70°C (SoM @7W/10W/15W TDP, w/ 30W PoE PSE)</p> <p>TPM: N/A</p> <p>OS: BSP w/ JetPack 5.1.1, Ubuntu 20.04 @kernel 5.10</p>			
Others	<p>Dimensions (mm): 213.0 x 167.0 x 82.8</p>			



Based on different MXM for ATC 8010 and ATC 8010-F, the quantity will be different.

Product appearance and specifications are subject to change without notice.

Product appearance and specifications are subject to change without notice.



Vehicle Telematics Computer



VTC Series Brief Product Introduction

Product Description

VTC and MVS series are fanless embedded telematics system which can sustain in harsh environment, with rich I/O connectivity for external peripherals, and easy RF communication expansion. The modular design makes the

MVS series very flexible to adopt other expansion boards and thus extend I/O functions. Besides, we provide MUT (MCU Utility Tools) SDK for power management & control, which greatly reduces Time-To-Market.

-  5G/LTE, Wi-Fi 6/6E, BT, CAN/OBD module support
-  IP65/67 ingress protection

-  Ignition power management
-  AI accelerator module support

Application

- Fleet management
- Vehicle gateway
- Video surveillance
- Passenger information system
- Infotainment applications.

Product Highlight



Rugged design for harsh environment







Flexible RF communication expansion



Dead reckoning & RTK precise positioning







802.3 af/at PoE+ support



Model			 Coming soon	
	VTC 210	VTC 1910-S	VTC 1920	VTC 1911-IPK
System				
CPU	Rockchip RK3328	Intel Atom® E3815, 1 Core, 1.46GHz	Intel Atom® x7211RE, 2 Core, 2.9GHz	Intel Atom® E3815, 1 Core, 1.46GHz
Chipset	N/A	N/A	N/A	N/A
Memory	DDR4 2GB onboard, up to 4GB	1 x DDR3L 1600 SO-DIMM, 4GB (default) up to 8GB	1 x DDR4 3200 SO-DIMM, 4GB (default) up to 16GB, in-band ECC support	1 x DDR3L 1600 SO-DIMM, 4GB (default) up to 8GB
Storage	eMMC 5.1, 16GB	1 x SATA 2.0 mSATA	1 x M.2 2242 Key M SSD (SATA 3.0)	1 x SATA 2.0 mSATA
Second Storage	1 x Micro SD	1 x SATA DOM	N/A	1 x 2.5" SSD (9.5mm) or 1 x SATA DOM
Video Out	1 x HDMI	1 x VGA	1 x HDMI	1 x VGA, 1 x HDMI (optional)
Audio	N/A	1 x Mic-in, 1 x Line-out	1 x Mic-in, 1 x Line-out	1 x Mic-in, 1 x Line-out
Ethernet	2 x 10/100/1000 LAN switch	1 x Intel® 10/100/1000	1 x Intel® 10/100/1000/2500	2 x Intel® 10/100/1000
PoE	N/A	N/A	N/A	N/A
I/O Interface				
USB	1 x External USB 2.0, 1 x Internal USB 2.0 for Wi-Fi	1 x USB 3.0, 1 x USB 2.0	2 x USB 3.2 (Gen 2)	1 x USB 2.0
COM	1 x RS232 (full)	2 x RS232 (Tx, Rx), 1 x RS485	2 x RS232 (Tx, Rx), 1 x RS485	2 x RS232 (Tx, Rx), 1 x RS485
DIO	N/A	3 x DI, 3 x DO	3 x DI, 3 x DO	3 x DI, 3 x DO
CAN Bus	N/A	1 x CAN Bus 2.0B	1 x CAN FD	1 x CAN Bus 2.0B
DC Output	N/A	N/A	N/A	N/A
SIM Socket	1	2	2	2
Expansion				
WWAN	1	1	1	1
mini-PCIe Socket	N/A	- 1 x (PCIe 2.0/SATA 2.0) - 1 x (USB 2.0) for LTE	- 1 x (USB 2.0) for Wi-Fi - BOM option to 1 x M.2 3052 Key B socket (USB 2.0) for LTE	- 1 x (USB 2.0, PCIe 2.0/SATA 2.0) - 1 x (USB 2.0) for LTE
M.2 Socket	- 1 x M.2 3042 Key B (USB 2.0, USB 3.2 (Gen1)) for LTE	N/A	- 1 x M.2 3042/3050/3052 Key B (USB 2.0, USB 3.2 (Gen 2)) for LTE/5G - 1 x M.2 2230 Key E (USB 2.0, PCIe 3.0 x1)	N/A
GNSS	VI0B-GPS-06 module (u-blox NEO-M9N)	Onboard u-blox NEO-M8N	Onboard u-blox NEO-M9N	Onboard u-blox NEO-M8N
Power				
Power Input	DC 9V to 36V	DC 9V to 36V	DC 9V to 36V	DC 9V to 36V
Back Up Battery	N/A	N/A	N/A	N/A
Environment				
Ingress Protection	N/A	N/A	N/A	IP67
Certification	CE, FCC Class A, UKCA, E13	CE, FCC Class A, E13	CE, FCC Class A, E13	CE, FCC Class A, E13, EN50155
Operating Temperature	-20°C to 70°C	-40°C to 70°C	-40°C to 70°C	-40°C to 70°C
Others				
TPM	N/A	TPM 2.0	TPM 2.0	TPM 2.0
OS	Linux	Win 10, Win 8, Win 7, WES 7, Linux (Kernel 4.x)	Win 10, Win 11, Linux (Kernel 4.x)	Win 10, Win 8, Win 7, WES 7, Linux (Kernel 4.x)
Dimensions (mm)	130 x 100 x 31	130 x 120 x 32	130 x 120 x 32	185 x 167 x 56.5



Vehicle Telematics Computer



Model				
	VTC 1011-C2K	VTC 1011-C2VK	VTC 1020	VTC 1020-PA
System				
CPU	Intel Atom® E3825, 2 Core, 1.33GHz	Intel Atom® E3825, 2 Core, 1.33GHz	Intel Atom® x5-E3930, 2 Core, 1.8GHz	Intel Atom® x5-E3930, 2 Core, 1.8GHz
Chipset	N/A	N/A	N/A	N/A
Memory	1 x DDR3L 1600 SO-DIMM, 4GB (default) up to 8GB	1 x DDR3L 1600 SO-DIMM, 4GB (default) up to 8GB	1 x DDR3L 1866 SO-DIMM, 4GB (default) up to 8GB	1 x DDR3L 1866 SO-DIMM, 4GB (default) up to 8GB
Storage	1 x 2.5" SATA 2.0 SSD (9.5mm)	1 x 2.5" SATA 2.0 SSD (9.5mm)	1 x 2.5" SATA 3.0 SSD (9.5mm)	1 x 2.5" SATA 3.0 SSD (15mm)
Second Storage	1 x mSATA (occupied mini-PCIe socket)	1 x mSATA (occupied mini-PCIe socket)	1 x mSATA (occupied mini-PCIe socket)	1 x mSATA (occupied mini-PCIe socket)
I/O Interface				
Video Out	1 x VGA, 1 x HDMI	1 x VGA, 1 x HDMI, 1 x ultraONE+	1 x VGA, 1 x HDMI	1 x VGA, 1 x HDMI, 1 x LVDS
Audio	1 x Mic-in, 1 x Line-out	1 x Mic-in, 1 x Line-out	1 x Mic-in, 1 x Line-out	1 x Mic-in, 3 x Line-out (selectable)
Ethernet	2 x Intel® 10/100/1000 (exclusion with PoE)	2 x Intel® 10/100/1000 (exclusion with PoE)	1 x Intel® 10/100/1000	1 x Intel® 10/100/1000
PoE	2 x Intel® 10/100/1000 (w/ 802.3at/af). Total 30W	2 x Intel® 10/100/1000 (w/ 802.3at/af). Total 30W	N/A	N/A
USB	2 x USB 2.0	2 x USB 2.0	2 x USB 3.2 (Gen1)	2 x USB 3.2 (Gen1)
COM	1 x RS232 (full), 1 x RS232 (Tx, Rx)/RS422/485	1 x RS232 (full), 1 x RS232 (Tx, Rx)/RS422/485	5 x RS232 (Tx, Rx), 2 x RS485	5 x RS232 (Tx, Rx), 2 x RS485
DIO	4 x DI, 4 x DO	4 x DI, 4 x DO	5 x Programmable DIO	5 x Programmable DIO
CAN Bus	1 x CAN Bus 2.0B	1 x CAN Bus 2.0B	1 x CAN Bus 2.0B	1 x CAN Bus 2.0B
DC Output	12V (2A)	12V (2A)	12V (2A)	12V (2A)
SIM Socket	2	2	1	1
WWAN	1	1	1	1
Expansion				
mini-PCIe Socket	- 1 x (USB 2.0, PCIe 2.0/ SATA 2.0) - 1 x (USB 2.0) for LTE	- 1 x (USB 2.0, PCIe 2.0/ SATA 2.0) - 1 x (USB 2.0) for LTE	- 1 x (USB 2.0, PCIe 2.0/ SATA 3.0) - 1 x (USB 2.0) for LTE	- 1 x (USB 2.0, PCIe 2.0/ SATA 3.0) - 1 x (USB 2.0) for LTE
M.2 Socket	N/A	N/A	N/A	N/A
GNSS	VIOB-GPS-02 module (u-blox NEO-M8N)	VIOB-GPS-02 module (u-blox NEO-M8N)	VIOB-GPS-02 module (u-blox NEO-M8N)	VIOB-GPS-02 module (u-blox NEO-M8N)
Power				
Power Input	DC 9V to 36V	DC 9V to 36V	DC 9V to 36V	DC 9V to 36V
Back Up Battery	N/A	N/A	N/A	N/A
Environment				
Ingress Protection	N/A	N/A	N/A	N/A
Certification	CE, FCC Class A, UKCA, E13	CE, FCC Class A, UKCA, E13	CE, FCC Class A, UKCA, E13	CE, FCC Class A, UKCA, E13
Operating Temperature	-40°C to 70°C (LAN mode) -40°C to 60°C (PoE mode)	-40°C to 70°C (LAN mode) -40°C to 60°C (PoE mode)	-40°C to 70°C	-40°C to 70°C
Others				
TPM	TPM 2.0	TPM 2.0	TPM 2.0	TPM 2.0
OS	Win 10, Win 8, Win 7, WES 7, Linux (Kernel 4.x)	Win 10, Win 8, Win 7, WES 7, Linux (Kernel 4.x)	Win 10, Linux (Kernel 4.x)	Win 10, Linux (Kernel 4.x)
Dimensions (mm)	185 x 150.9 x 45	185 x 150.9 x 45	185 x 120 x 45	185 x 120 x 50







Model			
	VTC 1010	VTC1021-BK	VTC1021-C2K
System			
CPU	Intel Atom® E3827, 2 Core, 1.75GHz	Intel Atom® x5-E3940, 4 Core, 1.8GHz	Intel Atom® x5-E3940, 4 Core, 1.8GHz
Chipset	N/A	N/A	N/A
Memory	1 x DDR3L 1333 SO-DIMM, 4GB (default) up to 8GB	1 x DDR3L 1866 SO-DIMM, 4GB (default) up to 8GB	1 x DDR3L 1866 SO-DIMM, 4GB (default) up to 8GB
Storage	1 x 2.5" SATA 2.0 SSD (9.5mm)	1 x 2.5" SATA 3.0 SSD (9.5mm)	1 x 2.5" SATA 3.0 SSD (9.5mm)
Second Storage	1 x SD, mini-PCIe (occupied mini-PCIe socket)	1 x mSATA (occupied mini-PCIe socket)	1 x mSATA (occupied mini-PCIe socket)
I/O Interface			
Video Out	1 x VGA, 1 x DP	1 x VGA, 1 x HDMI	1 x VGA, 1 x HDMI
Audio	2 x Mic-in, 2 x Line-out	1 x Mic-in, 1 x Line-out	1 x Mic-in, 1 x Line-out
Ethernet	1 x Intel® 10/100/1000	2 x Intel® 10/100/1000	2 x Intel® 10/100/1000
PoE	N/A	N/A	2 x Intel® 10/100/1000 (w/ 802.3at/af). Total 60W
USB	1 x USB 3.2 (Gen1), 2 x USB 2.0	1 x USB 3.2 (Gen1), 2 x USB 2.0	1 x USB 3.2 (Gen1), 2 x USB 2.0
COM	2 x RS232 (full), 1 x RS422/485	1 x RS232 (full), 1 x RS232 (Tx, Rx), 1 x RS422/485	1 x RS232 (full), 1 x RS232 (Tx, Rx), 1 x RS422/485
DIO	6 x Programmable DIO	3 x DI, 3 x DO	3 x DI, 3 x DO
CAN Bus	1 x CAN Bus 2.0B	1 x CAN Bus 2.0B	1 x CAN Bus 2.0B
DC Output	12V (1A)	12V (2A)	12V (2A)
SIM Socket	2	2	2
WWAN	2	1	1
Expansion			
mini-PCIe Socket	- 2 x (USB 2.0, PCIe 2.0) - 1 x (SATA or (USB 2.0 + PCIe)) - 1 x (USB 2.0) for LTE	- 1 x (USB 2.0, PCIe 2.0/SATA 3.0) - 1 x (USB 2.0, PCIe 2.0) - 1 x (USB 2.0) for LTE	- 1 x (USB 2.0, PCIe 2.0/SATA 3.0) - 1 x (USB 2.0, PCIe 2.0) - 1 x (USB 2.0) for LTE
M.2 Socket	N/A	N/A	N/A
GNSS	VIOB-GPS-02 module (u-blox NEO-M8N)	Onboard u-blox NEO-M8N	Onboard u-blox NEO-M8N
Power			
Power Input	DC 9V to 36V	DC 9V to 36V	DC 9V to 36V
Back Up Battery	N/A	Optional	N/A
Environment			
Ingress Protection	N/A	N/A	N/A
Certification	CE, FCC Class B, UKCA, E13	CE, FCC Class B, UKCA, E13	CE, FCC Class B, UKCA, E13
Operating Temperature	-30°C to 70°C	-40°C to 70°C	-40°C to 70°C
Others			
TPM	N/A	TPM 2.0	TPM 2.0
OS	Win 10, Win 8, Win 7, WES 7, Linux (Kernel 4.x)	Win 10, Linux (Kernel 4.x)	Win 10, Linux (Kernel 4.x)
Dimensions (mm)	180 x 180 x 50	180 x 180 x 50	180 x 180 x 50



Vehicle Telematics Computer





Model	 NEW	 NEW	 NEW
	VTC 1030	VTC 1031	VTC 1031-C2
System			
CPU	Intel Atom® x6211E, 2 Core, 3.0GHz	Intel Atom® x6413E, 4 Core, 3.0GHz	Intel Atom® x6413E, 4 Core, 3.0GHz
Chipset	N/A	N/A	N/A
Memory	1 x DDR4 2666 SO-DIMM, 4GB (default) up to 3200MHz 32GB, in-band ECC support	1 x DDR4 2666 SO-DIMM, 4GB (default) up to 3200MHz 32GB, in-band ECC support	1 x DDR4 2666 SO-DIMM, 4GB (default) up to 3200MHz 32GB, in-band ECC support
Storage	1 x 2.5" SATA 3.0 SSD (9.5mm)	1 x 2.5" SATA 3.0 SSD (9.5mm)	1 x 2.5" SATA 3.0 SSD (9.5mm)
Second Storage	1 x mSATA (occupied mini-PCIe socket)	1 x M.2 2280 Key M SSD (SATA 3.0)	1 x M.2 2280 Key M SSD (SATA 3.0)
Video Out	1 x VGA, 1 x HDMI	1 x VGA, 1 x HDMI	1 x VGA, 1 x HDMI
Audio	1 x Mic-in, 1 x Line-out	1 x Mic-in, 1 x Line-out	1 x Mic-in, 1 x Line-out
Ethernet	2 x Intel® 10/100/1000/2500	1 x Intel® 10/100/1000/2500 1 x 10/100/1000	1 x Intel® 10/100/1000/2500 1 x 10/100/1000
PoE	N/A	N/A	2 x Independent Intel® 10/100/1000 (w/ 802.3at/af). Total 60W
I/O Interface			
USB	2 x USB 3.2 (Gen 2)	1 x USB 3.2 (Gen 2), 3 x USB 2.0	1 x USB 3.2 (Gen 2), 3 x USB 2.0
COM	2 x RS232 (full)/422/485	1 x RS232 (full)/422/485, 1 x RS232 (Tx, Rx), 2 x RS485	1 x RS232 (full)/422/485, 1 x RS232 (Tx, Rx), 2 x RS485
DIO	5 x DI, 4 x DO	5 x DI, 4 x DO	5 x DI, 4 x DO
CAN Bus	1 x CAN Bus 2.0B (w/ isolation)	1 x CAN Bus 2.0B (w/ isolation)	1 x CAN Bus 2.0B (w/ isolation)
DC Output	12V (2A)	12V (2A)	12V (2A)
SIM Socket	2	2	2
WWAN	1	1	1
Expansion			
mini-PCIe Socket	1 x (USB 2.0, PCIe 3.0/SATA 3.0)	- 1 x (USB 2.0, PCIe 3.0) - BOM option to 1 x M.2 3042 Key B socket (USB 2.0, USB 3.2 Gen 2x1) for LTE/5G NR	- 1 x (USB 2.0, PCIe 3.0) - BOM option to 1 x M.2 3042 Key B socket (USB 2.0, USB 3.2 Gen 2x1) for LTE/5G NR
M.2 Socket	- 1 x M.2 3042/3050/3052 Key B (USB 2.0, USB 3.2 (Gen 2)) for LTE/5G - 1 x M.2 2230 Key E (USB 2.0, PCIe 3.0 x2) BOM option to 1 x M.2 2230 Key E (USB 2.0, PCIe 3.0, PCIe 3.0)	- 1 x M.2 3042/3050/3052 Key B (USB 2.0, USB 3.2 (Gen 2)) for LTE/5G - 1 x M.2 2230 Key E (USB 2.0, PCIe 3.0 x2) BOM option to 1 x M.2 2230 Key E (USB 2.0, PCIe 3.0, PCIe 3.0)	- 1 x M.2 3042/3050/3052 Key B (USB 2.0, USB 3.2 (Gen 2)) for LTE/5G - 1 x M.2 2230 Key E (USB 2.0, PCIe 3.0 x2) BOM option to 1 x M.2 2230 Key E (USB 2.0, PCIe 3.0, PCIe 3.0)
GNSS	VIOB-GPS-06 module (u-blox NEO-M9N)	VIOB-GPS-06 module (u-blox NEO-M9N)	VIOB-GPS-06 module (u-blox NEO-M9N)
Power Environment			
Power Input	DC 9V to 36V	DC 9V to 36V	DC 9V to 36V
Back Up Battery	N/A	N/A	N/A
Ingress Protection	N/A	N/A	N/A
Certification	CE, FCC Class A, UKCA, E13	CE, FCC Class A, UKCA, E13	CE, FCC Class A, UKCA, E13
Operating Temperature	-40°C to 70°C	-40°C to 70°C	-40°C to 70°C
TPM	TPM 2.0	TPM 2.0	TPM 2.0
Others			
OS	Win 10, Win 11, Linux (Kernel 4.x)	Win 10, Win 11, Linux (Kernel 4.x)	Win 10, Win 11, Linux (Kernel 4.x)
Dimensions (mm)	185 x 120 x 45	180 x 180 x 50	180 x 180 x 50





Model				
	VTC 6210-BK	VTC 6210-VR4	VTC 6220-BK	VTC 6221
System				
CPU	Intel Atom® E3845, 4 Core, 1.91GHz	Intel Atom® E3845, 4 Core, 1.91GHz	Intel Atom® x7-E3950, 4 Core, 2.0GHz	Intel Atom® x7-E3950, 4 Core, 2.0GHz
Chipset	N/A	N/A	N/A	N/A
Memory	1 x DDR3L 1333 SO-DIMM, 4GB (default) up to 8GB	1 x DDR3L 1333 SO-DIMM, 4GB (default) up to 8GB	1 x DDR3L 1866 SO-DIMM, 4GB (default) up to 8GB	1 x DDR3L 1600 SO-DIMM, 4GB (default) up to 8GB
Storage	1 x 2.5" SATA 2.0 SSD/HDD (removable, 9.5mm)	1 x 2.5" SATA 2.0 SSD/HDD (removable, 9.5mm)	2 x 2.5" SATA 3.0 SSD/HDD (removable, 9.5mm)	1 x 2.5" SATA 3.0 SSD (removable, 9.5mm)
Second Storage	1 x CFast (external accessible)	1 x CFast (external accessible)	N/A	1 x CFast (external accessible), 1 x mSATA (occupied CFast, BOM optional)
Video Out	1 x VGA, 1 x DP	VGA, DP, 4 x (Video-in + Audio-in)	1 x VGA, 1 x HDMI, 1 x LVDS (optional), 1 x ultraONE+ (optional)	2 x VGA, 1 x HDMI
Audio	2 x Mic-in, 2 x Line-out	2 x Mic-in, 2 x Line-out	2 x Mic-in, 2 x Line-out	1 x Mic-in, 2 x Line-out
Ethernet	2 x Intel® 10/100/1000	2 x Intel® 10/100/1000	3 x Intel® 10/100/1000 (2 x LAN exclusion with PoE)	2 x Intel® 10/100/1000, (BOM option up to 3)
PoE	N/A	N/A	2 x Independent Intel® 10/100/1000 (w/ 802.3at/af). Total 30W (BOM optional)	N/A
I/O Interface				
USB	1 x USB 3.2 (Gen1), 2 x USB 2.0	1 x USB 3.2 (Gen1), 2 x USB 2.0	2 x USB 3.2 (Gen1), 1 x USB 2.0	1 x USB 3.2 (Gen1), 3 x USB 2.0
COM	2 x RS232 (Full), 1 x RS422/485	1 x RS232 (full), 1 x RS422/485	2 x RS232 (full), 1 x RS422/485	1 x RS232 (full), 1 x RS232 (Tx, Rx), 1 x RS485
DIO	8 x Programmable PC GPIO, 2 x MCU-DI, 2 x MCU-DO	8 x Programmable PC GPIO, 2 x MCU-DI, 2 x MCU-DO	4 x DI, 4 x DO	4 x DI, 4 x DO
CAN Bus	1 x CAN Bus 2.0B	1 x CAN Bus 2.0B	1 x CAN Bus 2.0B (w/ isolation)	1 x CAN Bus 2.0B (w/ isolation)
DC Output	12V (2A)	12V (2A)	12V (2A)	12V (2A)
SIM Socket	3	3	4	6 (BOM option up to 8, eSIM BOM optional)
WWAN	2	2	2	3 (BOM option up to 3)
Expansion				
mini-PCIe Socket	- 2 x (USB 2.0, PCIe 2.0) - 2 x (USB 2.0) for LTE	- 2 x (USB 2.0, PCIe 2.0) - 2 x (USB 2.0) for LTE	- 2 x (USB 2.0, PCIe 2.0) - 1 x (USB 2.0) for LTE - BOM option to 1 x M.2 3042 Key B (USB 2.0, USB 3.2 (Gen1)) for LTE/5G	- 2 x (USB 2.0, PCIe 2.0) - 1 x (USB 2.0) for LTE
M.2 Socket	N/A	N/A	- 1 x M.2 3042 Key B (USB 2.0, USB 3.2 (Gen1)) for LTE/5G	- 1 x M.2 3042/3052 Key B (USB 2.0, USB 3.0) for LTE/5G - 1 x M.2 3042 Key B (USB 2.0, USB 3.2 (Gen1)) for LTE/5G
GNSS	VIOB-GPS-02 module (u-blox NEO-M8N)	VIOB-GPS-02 module (u-blox NEO-M8N)	VIOB-GPS-02 module (u-blox NEO-M8N)	VIOB-GPS-02 module (u-blox NEO-M8N)
Power Environment				
Power Input	DC 9V to 36V	DC 9V to 36V	DC 9V to 36V	DC 9V to 48V
Back Up Battery	N/A	N/A	Optional	N/A
Ingress Protection	N/A	N/A	N/A	N/A
Certification	CE, FCC Class B, E13	CE, FCC Class B, UKCA, E13	CE, FCC Class A, UKCA, E13	CE, FCC Class A, UKCA, E13
Operating Temperature	-30°C to 70°C	-30°C to 70°C	-40°C to 70°C (w/o internal backup battery)	-40°C to 70°C
TPM	N/A	N/A	TPM 2.0	TPM 2.0, optional
Others				
OS	Win 10, Win 8, Win 7, WES 7, Linux (Kernel 4.x)	Win 10, Win 8, Win 7, WES 7, Linux (Kernel 4.x)	Win 10, Linux (Kernel 4.x)	Win 10, Linux (Kernel 4.x)
Dimensions (mm)	260 x 176 x 50	260 x 176 x 50	260 x 196 x 50	260 x 196 x 50



Vehicle Telematics Computer



Model	 Coming soon	 Coming soon		
	VTC 6231	VTC 6231-IP	VTC 6222-C4S	VTC 7250-7C8
System				
CPU	Intel Atom® x7433RE, 4 Core, 2.7GHz	Intel Atom® x7433RE, 4 Core, 2.7GHz	Intel Atom® x7-E3950, 4 Core, 2.0GHz	Intel® Core™ i7-8700T, 6 Core, 4.0GHz
Chipset	N/A	N/A	N/A	Intel® Q370
Memory	1 x DDR5 4800 SO-DIMM, 8GB (default) up to 16GB, in-band ECC support	1 x DDR5 4800 SO-DIMM, 8GB (default) up to 16GB, in-band ECC support	1 x DDR3L 1866 SO-DIMM, 4GB (default) up to 8GB	2 x DDR4 2666 SO-DIMM, 4GB + 4GB (default) up to 32GB+32GB
Storage	1 x 2.5" SATA 3.0 SSD (removable, 9.5mm)	1 x 2.5" SATA 3.0 SSD (removable, 9.5mm)	2 x 2.5" SATA 3.0 SSD (removable, 15mm)	2 x 2.5" SATA 3.0 SSD (removable, 15mm)
Second Storage	1 x mSATA (occupied mini-PCIe socket)	1 x mSATA (occupied mini-PCIe socket)	1 x SD (external accessible), 1 x Internal USB DOM	2 x mSATA 3.0 (BIOS selection)
I/O Interface				
Video Out	1 x VGA, 1 x HDMI, 1 x DP	1 x VGA, 1 x HDMI	1 x VGA, 2 x HDMI	1 x VGA, 1 x HDMI, 1 x ultraONE+
Audio	1 x Mic-in, 1 x Line-in, 1 x Line-out	1 x Mic-in, 1 x Line-in, 1 x Line-out	1 x Mic-in, 2 x Line-out	1 x Mic-in, 1 x Line-out
Ethernet	2 x Intel® 10/100/1000/2500	2 x Intel® 10/100/1000/2500	1 x Intel® 10/100/1000	1 x Intel® 10/100/1000
PoE	N/A	N/A	4 x Intel® 10/100/1000 (w/802.3at/af). Total 60W	8 x Independent Intel® 10/100/1000 (w/802.3at/af). Total 60W
USB	2 x USB 2.0, 2 x USB 3.2 (Gen2)	2 x USB 2.0, 2 x USB 3.2 (Gen2)	1 x USB 3.2 (Gen1), 2 x USB 2.0	6 x USB 3.2 (Gen2)
COM	2 x RS232 (Full)/422/485, 1 x RS232 (Full)	2 x RS232 (Full)/422/485, 1 x RS232 (Full)	1 x RS232 (Full), 1 x RS232 (Tx, Rx), 1 x RS422/485	2 x RS232 (Full), 1 x RS232 (Full)/422/485
DIO	4 x DI, 4 x DO	4 x DI, 4 x DO	4 x DI, 4 x DO (w/isolation)	4 x DI, 4 x DO
CAN Bus	1 x CAN FD (w/isolation)	1 x CAN FD (w/isolation)	1 x CAN Bus 2.0B (w/isolation)	1 x CAN Bus 2.0B (w/isolation)
DC Output	12V (2A)	12V (2A)	12V (2A)	12V (2A)
SIM Socket	8 (eSIM BOM optional)	8 (eSIM BOM optional)	2 (eSIM BOM optional)	3 (eSIM BOM optional)
WWAN	4	4	1	2
Expansion				
mini-PCIe Socket	- 1 x (USB 2.0, SATA 3.0/PCIe 3.0) - 1 x (USB 2.0, PCIe 3.0) for Wi-Fi - BOM option to 1 x M.2 3052 Key B (USB 2.0, USB 3.2 Gen 2x1) for LTE/5G	- 1 x (USB 2.0, SATA 3.0/PCIe 3.0) - 1 x (USB 2.0, PCIe 3.0) for Wi-Fi - BOM option to 1 x M.2 3052 Key B (USB 2.0, USB 3.2 Gen 2x1) for LTE/5G	- 2 x (USB 2.0, PCIe 2.0) - 1 x (USB 2.0) for LTE - BOM option to 1 x M.2 3042 Key B (USB 2.0, USB 3.2 (Gen1)) for LTE/5G supported	- 2 x (USB 2.0, PCIe 3.0/SATA 3.0) - 1 x (USB 2.0) for LTE - BOM option to 1 x M.2 3042 Key B (USB 2.0, USB 3.1) for LTE/5G
M.2 Socket	- 2 x M.2 3042/3052 Key B (USB 2.0, USB 3.2) for LTE/5G - 1 x M.2 2230 Key E (PCIe 3.0 x 1, USB 2.0) for Wi-Fi	- 2 x M.2 3042/3052 Key B (USB 2.0, USB 3.2) for LTE/5G - 1 x M.2 2230 Key E (PCIe 3.0 x 1, USB 2.0) for Wi-Fi	N/A	- 1 x M.2 3042 Key B (USB 2.0, USB 3.2 (Gen1)) for LTE/5G
GNSS	VIOB-GPS-06 module (u-blox NEO-M9N)	VIOB-GPS-06 module (u-blox NEO-M9N)	u-blox NEO-M8N onboard	VIOB-GPS-02 module (u-blox NEO-M8N)
Power				
Power Input	DC 9V to 36V	DC 9V to 36V	DC 9V to 48V	DC 9V to 36V
Back Up Battery	N/A	N/A	N/A	N/A
Environment				
Ingress Protection	N/A	IP67	N/A	N/A
Certification	CE, FCC Class A, UKCA, E13	CE, FCC Class A, UKCA, E13	CE, FCC Class A, UKCA, E13	CE, FCC Class A, UKCA, E13
Operating Temperature	-40°C to 70°C	-40°C to 70°C	-40°C to 70°C	-30°C to 60°C
Others				
TPM	TPM 2.0	TPM 2.0	TPM 2.0, optional	TPM 2.0
OS	Win 10, Win 11, Linux (Kernel 4.x)	Win 10, Win 11, Linux (Kernel 4.x)	Win 10, Linux (Kernel 4.x)	Win 10/11, Linux (Kernel 4.x)
Dimensions (mm)	260 x 196 x 50	260 x 196 x 70	260 x 196 x 66.5	260 x 256 x 90.1





Model			
	VTC 7251	VTC 7251-7C4	VTC 7252-7C4IP
System			
CPU	Intel® Core™ i7-8700T, 6 Core, 4.0GHz	Intel® Core™ i7-8700T, 6 Core, 4.0GHz	Intel® Core™ i7-9700TE, 8 Core, 3.8GHz
Chipset	Intel® Q370	Intel® Q370	Intel® C246
Memory	2 x DDR4 2666 SO-DIMM, 4GB + 4GB (default) up to 32GB+32GB	2 x DDR4 2666 SO-DIMM, 4GB + 4GB (default) up to 32GB+32GB	2 x DDR4 2666 SO-DIMM, 4GB + 4GB (default) up to 32GB+32GB
Storage	2 x 2.5" SATA 3.0 SSD (removable, 15mm)	2 x 2.5" SATA 3.0 SSD (removable, 15mm)	2 x 2.5" SATA 3.0 SSD (9.5 mm)
Second Storage	2 x mSATA 3.0 (BIOS selection)	2 x mSATA 3.0 (BIOS selection)	2 x mSATA 3.0 (BIOS selection), 1 x CFAST (external accessible)
I/O Interface			
Video Out	1 x VGA, 1 x HDMI	1 x VGA, 1 x HDMI	1 x VGA, 1 x HDMI (optional)
Audio	1 x Mic-in, 2 x Line-out	1 x Mic-in, 2 x Line-out	1 x Mic-in, 2 x Line-out
Ethernet	2 x Intel® 10/100/1000	1 x Intel® 10/100/1000	2 x Intel® 10/100/1000
PoE	N/A	4 x Independent Intel® 10/100/1000 (w/802.3at/af). Total 60W	4 x Independent Intel® 10/100/1000 (w/802.3at/af). Total 60W
USB	6 x USB 3.2 (Gen2)	6 x USB 3.2 (Gen2)	2 x USB 3.2 (Gen2), 2 x USB 2.0
COM	2 x RS232 (Full), 1 x RS232 (Full)/422/485	2 x RS232 (Full), 1 x RS232 (Full)/422/485	2 x RS232 (Full), 1 x RS232 (Full)/422/485
DIO	4 x DI, 4 x DO	4 x DI, 4 x DO	3 x DI, 3 x DO
CAN Bus	1 x CAN Bus 2.0B (w/isolation)	1 x CAN Bus 2.0B (w/isolation)	2 x CAN Bus 2.0B (w/isolation)
DC Output	12V (2A)	12V (2A)	12V (2A) (internal reserved)
SIM Socket	6 (BOM option up to 8, eSIM BOM optional)	6 (BOM option up to 8, eSIM BOM optional)	2 (eSIM BOM optional)
WWAN	3 (BOM option up to 4)	3 (BOM option up to 4)	1
Expansion			
mini-PCIe Socket	- 2 x (USB 2.0, PCIe 3.0/SATA 3.0) - 2 x (USB 2.0) for LTE - BOM option to 2 x M.2 3042 Key B (USB 2.0, USB 3.1) for LTE/5G	- 2 x (USB 2.0, PCIe 3.0/SATA 3.0) - 2 x (USB 2.0) for LTE - BOM option to 2 x M.2 3042 Key B (USB 2.0, USB 3.1) for LTE/5G	- 2 x (USB 2.0, PCIe 3.0/SATA 3.0)
M.2 Socket	- 1 x M.2 3042/3052 Key B (USB 2.0, USB 3.2 (Gen1)) for LTE/5G	- 1 x M.2 3042/3052 Key B (USB 2.0, USB 3.2 (Gen1)) for LTE/5G	- 1 x M.2 3042/3052 Key B (USB 2.0, USB 3.2 (Gen1)) for LTE/5G - 1 x M.2 2230 Key E (USB 2.0, 2 x PCIe 3.0). BOM option to 1 x mini-PCIe (USB 2.0, PCIe 3.0).
GNSS	VIOB-GPS-02 module (u-blox NEO-M8N)	VIOB-GPS-02 module (u-blox NEO-M8N)	VIOB-GPS-02 module (u-blox NEO-M8N)
Power			
Power Input	DC 9V to 36V	DC 9V to 36V	DC 9V to 36V
Back Up Battery	N/A	N/A	N/A
Environment			
Ingress Protection	N/A	N/A	IP65
Certification	CE, FCC Class A, UKCA, E13	CE, FCC Class A, UKCA, E13	CE, FCC Class A, UKCA, E13
Operating Temperature	-30°C to 70°C	-30°C to 60°C	-30°C to 60°C
Others			
TPM	TPM 2.0	TPM 2.0	TPM 2.0
OS	Win 10/11, Linux (Kernel 4.x)	Win 10/11, Linux (Kernel 4.x)	Win 10/11, Linux (Kernel 4.x)
Dimensions (mm)	260 x 256 x 83.5	260 x 256 x 83.5	260 x 256 x 66.5



Vehicle Telematics Computer





Model	 NEW	 NEW	 NEW
	VTC 7260-5	VTC 7260-5C4	VTC 7260-7
System			
CPU	Intel® Core™ i5-1145GRE, 4 Core, 2.6GHz	Intel® Core™ i5-1145GRE, 4 Core, 2.6GHz	Intel® Core™ i7-1185GRE, 4 Core, 2.8GHz
Chipset	N/A	N/A	N/A
Memory	2 x DDR4 3200 SO-DIMM, 4GB+4GB (default) up to 32GB+32GB, in-band ECC support	2 x DDR4 3200 SO-DIMM, 4GB+4GB (default) up to 32GB+32GB, in-band ECC support	2 x DDR4 3200 SO-DIMM, 4GB+4GB (default) up to 32GB+32GB, in-band ECC support
Storage	1 x 2.5" SATA 3.0 SSD (15mm)	1 x 2.5" SATA 3.0 SSD (15mm)	1 x 2.5" SATA 3.0 SSD (15mm)
Second Storage	1 x mSATA 3.0, 1 x M.2 2280 Key M NVMe (PCIe4.0 x4)	1 x mSATA 3.0, 1 x M.2 2280 Key M NVMe (PCIe4.0 x4)	1 x mSATA 3.0, 1 x M.2 2280 Key M NVMe (PCIe4.0 x4)
Video Out	1 x VGA, 1 x HDMI, 1 x DP	1 x VGA, 1 x HDMI, 1 x DP	1 x VGA, 1 x HDMI, 1 x DP
Audio	1 x Mic-in, 1 x Line-out	1 x Mic-in, 1 x Line-out	1 x Mic-in, 1 x Line-out
Ethernet	1 x Intel® 10/100/1000 (WoL, PXE, iamt support), 2 x Independent Intel® 2.5GbE	1 x Intel® 10/100/1000 (WoL, PXE, iamt support)	1 x Intel® 10/100/1000 (WoL, PXE, iamt support), 2 x Independent Intel® 2.5GbE
I/O Interface			
PoE	N/A	4 x Independent Intel® 2.5GbE (IEEE 802.3at/af, total 60W)	N/A
USB	3 x USB 3.2 (Gen1), 1 x USB 2.0	3 x USB 3.2 (Gen1), 1 x USB 2.0	3 x USB 3.2 (Gen1), 1 x USB 2.0
COM	1 x RS232 (full), 2 x RS232 (full)/422/485	2 x RS232 (full)/422/485	1 x RS232 (full), 2 x RS232 (full)/422/485
DIO	4 x DI, 4 x DO	4 x DI, 4 x DO	4 x DI, 4 x DO
CAN Bus	1 x CAN Bus 2.0B (w/ isolation)	1 x CAN Bus 2.0B (w/ isolation)	1 x CAN Bus 2.0B (w/ isolation)
DC Output	N/A	N/A	N/A
SIM Socket	4	4	4
WWAN	1~2	1~2	1~2
Expansion			
mini-PCIe Socket	- 1 x (USB 2.0/3.2, PCIe 3.0)	- 1 x (USB 2.0/3.2, PCIe 3.0)	- 1 x (USB 2.0/3.2, PCIe 3.0)
M.2 Socket	- 1 x M.2 3042/3052 Key B (USB 3.2 (Gen2)) for LTE/5G - 1 x M.2 3030 Key E (PCIe 3.0 x2, USB 2.0) for Wi-Fi/ Hailo AI card	- 1 x M.2 3042/3052 Key B (USB 3.2 (Gen2)) for LTE/5G - 1 x M.2 3030 Key E (PCIe 3.0 x2, USB 2.0) for Wi-Fi/ Hailo AI card	- 1 x M.2 3042/3052 Key B (USB 3.2 (Gen2)) for LTE/5G - 1 x M.2 3030 Key E (PCIe 3.0 x2, USB 2.0) for Wi-Fi/ Hailo AI card
GNSS	VIOB-GPS-06 module (u-blox NEO-M9N)	VIOB-GPS-06 module (u-blox NEO-M9N)	VIOB-GPS-06 module (u-blox NEO-M9N)
Power			
Power Input	DC 9V to 36V	DC 9V to 36V	DC 9V to 36V
Back Up Battery	N/A	N/A	N/A
Ingress Protection	N/A	N/A	N/A
Environment			
Certification	CE, FCC Class A, UKCA, E13	CE, FCC Class A, UKCA, E13	CE, FCC Class A, UKCA, E13
Operating Temperature	-30°C~65/70°C (15W/12W TDP)	-30°C to 65/70°C (15W/12W TDP)	-30°C to 65/70°C (15W/12W TDP)
TPM	TPM 2.0	TPM 2.0	TPM 2.0
Others			
OS	Win 10/11, Linux (Kernel 5.x)	Win 10/11, Linux (Kernel 5.x)	Win 10/11, Linux (Kernel 5.x)
Dimensions (mm)	210 x 173 x 75	210 x 173 x 75	210 x 173 x 75



Model	 NEW	 NEW	 NEW
	VTC 7260-7C4	VTC 7270	VTC 7270-C4/C8
System			
CPU	Intel® Core™ i7-1185GRE, 4 Core, 2.8GHz	12th/13th Gen Intel® Core™ i	12th/13th Gen Intel® Core™ i
Chipset	N/A	Intel® R680E	Intel® R680E
Memory	2 x DDR4 3200 SO-DIMM, 4GB+4GB (default) up to 32GB+32GB, in-band ECC support	2 x DDR5 4800 SO-DIMM, up to 32GB+32GB, ECC support	2 x DDR5 4800 SO-DIMM, up to 32GB+32GB, ECC support
Storage	1 x 2.5" SATA 3.0 SSD (15mm)	2 x 2.5" SATA 3.0 SSD (removable, 15mm)	2 x 2.5" SATA 3.0 SSD (removable, 15mm)
Second Storage	1 x mSATA 3.0, 1 x M.2 2280 Key M NVMe (PCIe4.0 x4)	1 x M.2 2280 Key M NVMe (PCIe4.0 x4)	1 x M.2 2280 Key M NVMe (PCIe4.0 x4)
Video Out	1 x VGA, 1 x HDMI, 1 x DP	1 x VGA, 1 x HDMI, 1 x DP	1 x VGA, 1 x HDMI, 1 x DP
Audio	1 x Mic-in, 1 x Line-out	1 x Mic-in, 1 x Line-in, 1 x Line-out	1 x Mic-in, 1 x Line-in, 1 x Line-out
Ethernet	1 x Intel® 10/100/1000 (WoL, PXE, iamt support)	1 x Intel® 10/100/1000 (WoL, PXE, iAMT support), 2 x Independent Intel® 2.5GbE	1 x Intel® 10/100/1000 (WoL, PXE, iamt support)
I/O Interface			
PoE	4 x Independent Intel® 2.5GbE (IEEE 802.3at/af, total 60W)	N/A	4/8 x Independent Intel® 2.5GbE (IEEE 802.3at/af, total 60W/120W)
USB	3 x USB 3.2 (Gen1), 1 x USB 2.0	6 x USB 3.2 (Gen2)	6 x USB 3.2 (Gen2)
COM	2 x RS232 (full)/422/485	2 x RS232 (full), 2 x RS232 (full)/422/485	2 x RS232 (full), 2 x RS232 (full)/422/485
DIO	4 x DI, 4 x DO	4 x DI, 4 x DO	4 x DI, 4 x DO
CAN Bus	1 x CAN Bus 2.0B (w/ isolation)	2 x CAN FD (w/ isolation)	2 x CAN FD (w/ isolation)
DC Output	N/A	12V (2A)	12V (2A)
SIM Socket	4	4	4
WWAN	1~2	1~2	1~2
Expansion			
mini-PCIe Socket	- 1 x (USB 2.0/3.2, PCIe 3.0)	- 1 x (PCIe 3.0, SATA 3.0, USB3.2), default PCIe 3.0 for Wi-Fi - 1 x (USB 3.2, PCIe 3.0, SATA 3.0), default USB 3.2 for LTE - Change interfaces by DIP switch setting	- 1 x (PCIe 3.0, SATA 3.0, USB3.2), default PCIe 3.0 for Wi-Fi - 1 x (USB 3.2, PCIe 3.0, SATA 3.0), default USB 3.2 for LTE - Change interfaces by DIP switch setting
M.2 Socket	- 1 x M.2 3042/3052 Key B (USB 3.2 (Gen2)) for LTE/5G - 1 x M.2 3030 Key E (PCIe 3.0 x2, USB 2.0) for Wi-Fi/ Hailo AI card	- 1 x M.2 3042/3052 Key B (USB 2.0, USB 3.2 (Gen2)) for LTE/5G - 1 x M.2 2230 Key E (PCIe 3.0 x2, USB 2.0) for Wi-Fi/Hailo AI card	- 1 x M.2 3042/3052 Key B (USB 2.0, USB 3.2 (Gen2)) for LTE/5G - 1 x M.2 2230 Key E (PCIe 3.0 x2, USB 2.0) for Wi-Fi/Hailo AI card
GNSS	VIOB-GPS-06 module (u-blox NEO-M9N)	VIOB-GPS-06 module (u-blox NEO-M9N)	VIOB-GPS-06 module (u-blox NEO-M9N)
Power			
Power Input	DC 9V to 36V	DC 9V to 36V	DC 9V to 36V
Back Up Battery	N/A	N/A	N/A
Ingress Protection	N/A	N/A	N/A
Environment			
Certification	CE, FCC Class A, UKCA, E13	CE, FCC Class A, UKCA, E13	CE, FCC Class A, UKCA, E13
Operating Temperature	-30°C to 60°C (15W TDP & PoE)	-35°C~70°C (35W CPU, fanless; 65W CPU, w/ fan)	-35°C~60°C/65°C (35W CPU, fanless, 120W/60W PoE; 65W CPU, w/ fan, 120W/60W PoE)
TPM	TPM 2.0	TPM 2.0	TPM 2.0
Others			
OS	Win 10/11, Linux (Kernel 5.x)	Win 10/11, Linux (Kernel 5.x)	Win 10/11, Linux (Kernel 5.x)
Dimensions (mm)	210 x 173 x 75	260 x 210 x 81	260 x 210 x 81



Modular Vehicle Computer System

Model					
	MVS 2620-IP	MVS 5600-3BU	MVS 5600-7BU	MVS 5600-3IPK	MVS 5600-7IPK
System					
CPU	Intel Atom® x7-E3950, 4 Core, 2.0GHz	Intel® Core™ i3-6100U, 2 Core, 2.3GHz	Intel® Core™ i7-6600U, 2 Core, 2.6GHz	Intel® Core™ i3-6100U, 2 Core, 2.3GHz	Intel® Core™ i7-6600U, 2 Core, 2.6GHz
Chipset	N/A	N/A	N/A	N/A	N/A
Memory	1 x DDR3L 1600/1866 SO-DIMM, 4GB (default) up to 8GB	2 x DDR3L 1600/1866 SO-DIMM, 2GB (default) up to 16GB	2 x DDR3L 1600/1866 SO-DIMM, 2GB (default) up to 16GB	2 x DDR3L 1600/1866 SO-DIMM, 2GB (default) up to 16GB	2 x DDR3L 1600 SO-DIMM, 2GB (default) up to 16GB
Storage	1 x 2.5" SATA 3.0 SSD/HDD	1 x 2.5" SATA 3.0 SSD/HDD (removable, 9.5mm)	1 x 2.5" SATA 3.0 SSD/HDD (removable, 9.5mm)	1 x 2.5" SATA 3.0 SSD/HDD	1 x 2.5" SATA 3.0 SSD/HDD
Second Storage	1 x CFast (external accessible)	1 x CFast (external accessible)	1 x CFast (external accessible)	1 x CFast (external accessible)	1 x CFast (external accessible)
Video Out	1 x VGA	1 x VGA, 1 x HDMI	1 x VGA, 1 x HDMI	1 x VGA	1 x VGA
Audio	1 x Mic-in, 2 x Line-out	2 x Mic-in, 2 x Line-out	2 x Mic-in, 2 x Line-out	1 x Mic-in, 2 x Line-out	1 x Mic-in, 2 x Line-out
Ethernet	2 x Intel® 10/100/1000	2 x Intel® 10/100/1000	2 x Intel® 10/100/1000	2 x Intel® 10/100/1000	2 x Intel® 10/100/1000
PoE	N/A	N/A	N/A	N/A	N/A
I/O Interface					
USB	3 x USB 2.0	4 x USB 3.2 (Gen1)	4 x USB 3.2 (Gen1)	1 x USB 3.2 (Gen1), 2 x USB 2.0	1 x USB 3.2 (Gen1), 2 x USB 2.0
COM	2 x RS232 (Full), 1 x RS232 (Tx/Rx), 2 x RS485	2 x RS232 (Full), 1 x RS232 (Full)/422/485	2 x RS232 (Full), 1 x RS232 (Full)/422/485	2 x RS232 (Full), 1 x RS232 (Tx/Rx), 2 x RS485	2 x RS232 (Full), 1 x RS232 (Tx/Rx), 2 x RS485
DIO	3 x DI (w/ isolation) 3 x DO (w/ isolation)	8 x Programmable DIO MCU: 2 x DI, 2 x DO, 1 x Speed frequency	8 x Programmable DIO MCU: 2 x DI, 2 x DO, 1 x Speed frequency	3 x DI (w/ isolation) 3 x DO (w/ isolation)	3 x DI (w/ isolation) 3 x DO (w/ isolation)
CAN Bus	1 x CANBus 2.0B (w/ isolation)	1 x CAN Bus 2.0B	1 x CAN Bus 2.0B	1 x CAN Bus 2.0B (w/ isolation)	1 x CAN Bus 2.0B (w/ isolation)
DC Output	12V (2A)	12V (2A)	12V (2A)	12V (2A)	12V (2A)
SIM Socket	3	3	3	3	3
WWAN	2	2	2	2	2
Expansion					
mini-PCIe Socket	- 1 x (USB 2.0, PCIe 2.0) for LTE - 1 x (USB 2.0) for LTE - 1 x (USB 2.0, PCIe 2.0) - 1 x (USB 2.0)	- 1 x (USB 2.0, PCIe 2.0) for LTE - 1 x (USB 2.0) for LTE - 1 x (USB 2.0, PCIe 2.0)	- 1 x (USB 2.0, PCIe 2.0) for LTE - 1 x (USB 2.0) for LTE - 1 x (USB 2.0, PCIe 2.0)	- 1 x (USB 2.0, PCIe 2.0) for LTE - 1 x (USB 2.0) for LTE - 1 x (USB 2.0, PCIe 2.0) - 1 x (USB 2.0)	- 1 x (USB 2.0, PCIe 2.0) for LTE - 1 x (USB 2.0) for LTE - 1 x (USB 2.0, PCIe 2.0) - 1 x (USB 2.0)
M.2 Socket	N/A	N/A	N/A	N/A	N/A
GNSS	VI0B-GPS-02 module (u-blox NEO-M8N)	VI0B-GPS-02 module (u-blox NEO-M8N)	VI0B-GPS-02 module (u-blox NEO-M8N)	VI0B-GPS-02 module (u-blox NEO-M8N)	VI0B-GPS-02 module (u-blox NEO-M8N)
Power					
Power Input	DC 9V to 36V	DC 9V to 36V	DC 9V to 36V	DC 9V to 36V	DC 9V to 36V
Back Up Battery	N/A	Internal (optional)	Internal (optional)	N/A	N/A
Environment					
Ingress Protection	IP65	N/A	N/A	IP65	IP65
Certification	CE, FCC Class A, UKCA, E13	CE, FCC Class A, UKCA, E13	CE, FCC Class A, UKCA, E13	CE, FCC Class A, UKCA, E13	CE, FCC Class A, UKCA, E13
Operating Temperature	Win 10, Linux (Kernel 4.x)	-30°C to 60°C (w/o internal back up battery)	-30°C to 60°C (w/o internal back up battery)	-30°C to 60°C	-30°C to 60°C
TPM	N/A	TPM 2.0, optional	TPM 2.0, optional	TPM 2.0, optional	TPM 2.0, optional
Others					
OS	260 x 198 x 50	Win 10, Win 8, WES 8, Win 7, WES 7, Linux (Kernel 4.x)	Win 10, Win 8, WES 8, Win 7, WES 7, Linux (Kernel 4.x)	Win 10, Win 8, WES 8, Win 7, WES 7, Linux (Kernel 4.x)	Win 10, Win 8, WES 8, Win 7, WES 7, Linux (Kernel 4.x)
Dimensions (mm)	-40°C to 70°C	260 x 196 x 66.5	260 x 196 x 66.5	260 x 198 x 66.5	260 x 198 x 66.5



Railway Computer - Box PC/Panel PC

nROK/vROK Series Brief Product Introduction

Product Description

nROK series, railway computer, in an extended operating temperature range of -40 to 70°C certified EN50155 and IP65 protection depended on models. The SKU with PoE integrated all-in-one computer can also work as a PoE switch and power supply for PoE cameras. Wide-range power input SKU from 24 to 110VDC includes isolation and protection against power dips. Multiple Wi-Fi 6/6E

and 5G/LTE cellular networks handle the connectivity that provides uninterrupted internet access and more transmission bandwidth, vROK series, all in one railway open frame panel computer, is designed for human machine interface (HMI) and passenger information system aimed at railway onboard infotainment applications.

 5G/LTE, Wi-Fi 6/6E, BT, CAN/OBD, GNSS + DR, POE, and multi-SIM integration

 Front accessible SSD storage

 Optional isolated 24~110VDC power input

 Global navigation satellite system for precise and real-time location

Application

nROK: Communications hub, passenger information system, onboard video surveillance, digital radio data/voice transmission system, freight management system, rail analytics system, rail maintenance applications.

vROK: Human machine interface (HMI), passenger information system, infotainment.

Product Highlight



EN50155 certified system



Protection for voltage dips

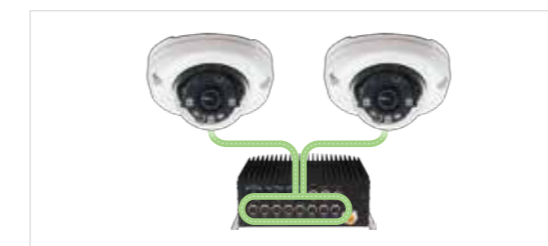



M12 X-coded/D-coded PoE port for IP cameras





Open frame design railway panel computer

Railway Computer - Box PC





Model			 NEW
	VTC 1911-IPK	nROK 1020-A	nROK 1030-A
System			
CPU	Intel Atom® E3815, 1 Core, 1.46GHz	Intel Atom® x5-E3930, 2 Core, 1.3GHz	Intel Atom® x6211E, 2 Core, 1.3GHz
Chipset	N/A	N/A	N/A
Memory	1 x DDR3L 1600 SO-DIMM, 2GB (default) up to 8GB	1 x DDR3L 1866 SO-DIMM, 4GB (default) up to 32GB	1 x DDR4 2666 SO-DIMM, 4GB (default) up to 3200MHz 32GB, in-band ECC support
Storage	1 x mSATA	1 x 2.5" SATA 3.0 SSD (9.5mm)	1 x 2.5" SATA 3.0 SSD (9.5mm)
Second Storage	1 x 2.5" SATA 3.0 SSD (9.5mm) or 1 x SATA DOM	1 x mSATA (occupied mPCIe socket)	1 x mSATA (occupied mPCIe socket)
Video Out	1 x VGA, 1 x HDMI (optional)	1 x VGA, 1 x HDMI	1 x VGA, 1 x HDMI
Audio	1 x Mic-in, 1 x Line-out (DB15)	1 x Mic-in, 1 x Line-out (M12)	1 x Mic-in, 1 x Line-out (DB9)
Ethernet	2 x Intel® 10/100/1000 (M12)	1 x Intel® 10/100/1000 (M12)	2 x Intel® 10/100/1000/2500 (M12)
I/O Interface			
PoE	N/A	N/A	N/A
USB	1 x USB 2.0	2 x USB 3.2 (Gen1)	1 x USB 3.2 (Gen2), 1 x USB 2.0
COM	2 x RS232 (Tx, Rx), 1 x RS485	5 x RS232 (Tx, Rx), 2 x RS485	2 x RS232 (Full)/422/485
DIO	3 x DI, 3 x DO	5 x Programmable DIO	5 x DI, 4 x DO
CAN Bus	1 x CAN Bus 2.0B	1 x CAN Bus 2.0B	1 x CAN Bus 2.0B (w/ isolation)
DC Output	N/A	12V (2A)	12V (2A)
SIM Socket	2	1	2 (eSIM BOM optional)
WWAN	1	1	1
Expansion			
mini-PCIe Socket	- 1 x (USB 2.0, PCIe 2.0/SATA 2.0) - 1 x (USB 2.0) for LTE	- 1 x (USB 2.0, PCIe 2.0/SATA 3.0) - 1 x (USB 2.0) for LTE	- 1 x (USB 2.0, PCIe 3.0/SATA 3.0)
M.2 Socket	N/A	N/A	- 1 x M.2 3042/3050/3052 Key B (USB 2.0, USB 3.2 (Gen 2))for LTE/5G - 1 x M.2 2230 Key E (USB 2.0, PCIe 3.0 x2) - BOM option to 1 x M.2 2230 Key E (USB 2.0, PCIe 3.0, PCIe 3.0)
GNSS	Onboard u-blox NEO-M8N	VIOB-GPS-02 module (u-blox NEO-M8N)	VIOB-GPS-06 module (u-blox NEO-M9N)
Power			
Power Input	DC 9V to 36V	DC 24V (w/o isolation)	DC 24V (w/o isolation)
Environment			
Ingress Protection	IP67	N/A	N/A
Certification	CE, FCC Class A, UKCA, E13, EN50155	CE, FCC Class A, UKCA, EN50155	CE, FCC Class A, UKCA, EN45545-2, EN50155
Operating Temperature	-40°C to 70°C (OT4)	-40°C to 70°C (OT4)	-40°C to 70°C (OT4)
TPM	TPM 2.0	TPM 2.0	TPM 2.0
Others			
OS	Win 10, Win 8, Win 7, WES 7, Linux (Kernel 4.x)	Win 10 64-bit, Linux (Kernel 4.x)	Win 10/11 64-bit, Linux (Kernel 5.x)
Dimensions (mm)	185 x 167 x 56.5	185 x 120 x 45	185 x 120 x 50





Model	 NEW	 NEW	
	nROK 1031-A	nROK 1031-AC2	VTC 6210-R
System			
CPU	Intel Atom® x6413E, 4 Core, 1.5GHz	Intel Atom® x6413E, 4 Core, 1.5GHz	Intel Atom® E3845, 4 Core, 1.91GHz
Chipset	N/A	N/A	N/A
Memory	1 x DDR4 2666 SO-DIMM, 4GB (default) up to 3200MHz 32GB, in-band ECC support	1 x DDR4 2666 SO-DIMM, 4GB (default) up to 3200MHz 32GB, in-band ECC support	1 x DDR3L 1600 SO-DIMM, 2GB (default) up to 8GB
Storage	1 x 2.5" SATA 3.0 SSD (9.5mm)	1 x 2.5" SATA 3.0 SSD (9.5mm)	1 x 2.5" SATA 2.0 SSD (removable, 9.5mm)
Second Storage	1 x M.2 2280 Key M NVMe SSD (SATA 3.0)	1 x M.2 2280 Key M NVMe SSD (SATA 3.0)	1 x CFast (external accessible)
Video Out	1 x VGA, 1 x HDMI	1 x VGA, 1 x HDMI	1 x VGA, 1 x DP
Audio	1 x Mic-in, 1 x Line-out (DB9)	1 x Mic-in, 1 x Line-out (DB9)	2 x Mic-in, 2 x Line-out (Phone Jack)
Ethernet	1 x Intel® 10/100/1000/2500 1 x 10/100/1000 (M12)	1 x Intel® 10/100/1000/2500 1 x 10/100/1000 (M12)	2 x Intel® 10/100/1000 (M12)
I/O Interface			
PoE	N/A	2 x M12 Independent Intel® 10/100/1000/2500 (802.3af/at). Total 60W	N/A
USB	1 x M12 with 2 x USB 2.0 signal, 1 x USB 2.0, 1 x USB 3.2 (Gen 2)	1 x M12 with 2 x USB 2.0 signal, 1 x USB 2.0, 1 x USB 3.2 (Gen 2)	1 x M12 with 2 x USB 2.0 signal, 1 x USB 3.2 (Gen1)
COM	1 x RS232 (Full)/422/485, 1 x RS232 (Tx, Rx), 2 x RS485	1 x RS232 (Full)/422/485, 1 x RS232 (Tx, Rx), 2 x RS485	2 x RS232 (Full), 1 x RS422/485. (w/ isolation)
DIO	5 x DI, 4 x DO	5 x DI, 4 x DO	4 x DI, 4 x DO (w/ isolation)
CAN Bus	1 x CAN Bus 2.0B (w/ isolation)	1 x CAN Bus 2.0B (w/ isolation)	1 x CAN Bus 2.0B (w/ isolation)
DC Output	12V (2A)	12V (2A)	N/A
SIM Socket	2 (eSIM BOM optional)	2 (eSIM BOM optional)	3
WWAN	1	1	2
Expansion			
mini-PCIe Socket	- 1 x (USB 2.0, PCIe 3.0) - BOM option to 1 x M.2 3042 Key B socket (USB 2.0, USB 3.2 (Gen 2)) for LTE/5G NR	- 1 x (USB 2.0, PCIe 3.0) - BOM option to 1 x M.2 3042 Key B socket (USB 2.0, USB 3.2 (Gen 2)) for LTE/5G NR	- 1 x (USB 2.0, PCIe 2.0) - 1 x (USB 2.0, PCIe 2.0) for LTE - 1 x (USB 2.0) for LTE
M.2 Socket	- 1 x M.2 3042/3050/3052 Key B (USB 2.0, USB 3.2 (Gen 2))for LTE/5G - 1 x M.2 2230 Key E (USB 2.0, PCIe 3.0 x2) - BOM option to 1 x M.2 2230 Key E (USB 2.0, PCIe 3.0, PCIe 3.0)	- 1 x M.2 3042/3050/3052 Key B (USB 2.0, USB 3.2 (Gen 2))for LTE/5G - 1 x M.2 2230 Key E (USB 2.0, PCIe 3.0 x2) - BOM option to 1 x M.2 2230 Key E (USB 2.0, PCIe 3.0, PCIe 3.0)	N/A
GNSS	VIOB-GPS-06 module (u-blox NEO-M9N)	VIOB-GPS-06 module (u-blox NEO-M9N)	VIOB-GPS-02 module (u-blox NEO-M8N)
Power			
Power Input	DC 24V (w/o isolation)	DC 24V (w/o isolation)	DC 24/36V (w/o isolation), 110V (w/ isolation)
Environment			
Ingress Protection	N/A	N/A	N/A
Certification	CE, FCC Class A, UKCA, EN50155	CE, FCC Class A, UKCA, EN50155	CE, FCC Class A, UKCA, EN50155
Operating Temperature	-40°C to 70°C (OT4)	-40°C to 70°C (OT4)	-40°C to 70°C (OT4)
TPM	TPM 2.0	TPM 2.0	N/A
Others			
OS	Win 10/11 64-bit, Linux (Kernel 5.x)	Win 10/11 64-bit, Linux (Kernel 5.x)	Win 10, Win 8, Win 7, WES 7, Linux (Kernel 4.x)
Dimensions (mm)	180 x 180 x 60	180 x 180 x 60	260 x 176 x 70



Railway Computer - Box PC



Model			 Coming soon	
	nROK 6221	nROK 6221-IP	nROK 6231-A	nROK 6222-AC4S
System				
CPU	Intel Atom® x7-E3950, 4 Core, 2.0GHz	Intel Atom® x7-E3950, 4 Core, 2.0GHz	Intel Atom® x7433RE, 4 Core, 2.7GHz	Intel Atom® x7-E3950, 4 Core, 2.0GHz
Chipset	N/A	N/A	N/A	N/A
Memory	1 x DDR3L 1600 SO-DIMM, 4GB (default) up to 8GB	1 x DDR3L 1866 SO-DIMM, 4GB (default) up to 8GB	1 x DDR5 4800 SO-DIMM, 8GB (default) up to 16GB, in-band ECC support	1 x DDR3L 1866 SO-DIMM, 4GB (default) up to 8GB
Storage	1 x 2.5" SATA 3.0 SSD (removable, 15mm)	1 x 2.5" SATA 3.0 SSD (removable, 15mm)	1 x 2.5" SATA 3.0 SSD (removable, 9.5mm)	2 x 2.5" SATA 3.0 SSD (removable, 15mm)
Second Storage	1 x CFast (external accessible, default) or 1 x mSATA (occupied CFast, BOM optional)	1 x CFast (external accessible, default) or 1 x mSATA (occupied CFast, BOM optional)	1 x mSATA (occupied mini-PCIe socket)	1 x SD (external accessible), 1 x internal USB DOM
Video Out	2 x VGA, 1 x HDMI	2 x VGA	1 x VGA, 1 x HDMI, 1 x DP	1 x VGA, 2 x HDMI
Audio	1 x Mic-in, 2 x Line-out (DB9)	1 x Mic-in, 1 x Line-out (M8)	1 x Mic-in, 1 x Line-in, 1 x Line-out	1 x Mic-in, 1 x Line-out (M8)
Ethernet	2 x Intel® 10/100/1000 (M12), (additional 1 x Intel® 10/100/1000 (M12), BOM optional)	2 x Intel® 10/100/1000 (M12), (additional 1 x Intel® 10/100/1000 (M12), BOM optional)	2 x Intel® 10/100/1000/2500	1 x Intel® 10/100/1000 (M12)
PoE	N/A	N/A	N/A	4 x M12 Intel® 10/100/1000 (802.3af/at), Total 60W
USB	1 x M12 with 2 x USB 2.0 signal, 1 x USB 2.0, 1 x USB 3.2 (Gen1)	1 x M12 with 2 x USB 2.0 signal, 1 x USB 3.2 (Gen1)	2 x USB 2.0, 2 x USB 3.2 (Gen2)	1 x M12 with 2 x USB 2.0 signal, 1 x USB 3.2 (Gen1)
COM	1 x RS232 (Full), 1 x RS232 (Tx, Rx), 1 x RS485. (w/ isolation)	1 x RS232 (Full), 1 x RS232 (Tx, Rx), 1 x RS485. (w/ isolation)	2 x RS232(full)/422/485, 1 x RS232 (Full)	1 x RS232 (Full), 1 x RS232 (Tx, Rx), 1 x RS422/485. (w/ isolation)
DIO	4 x DI, 4 x DO (w/ isolation)	4 x DI, 4 x DO (w/ isolation)	4 x DI, 4 x DO	4 x DI, 4 x DO (w/ isolation)
CAN Bus	1 x CAN Bus 2.0B (w/ isolation)	1 x CAN Bus 2.0B (w/ isolation)	1 x CAN FD (w/ isolation)	1 x CAN Bus 2.0B (w/ isolation)
DC Output	N/A	N/A	N/A	N/A
SIM Socket	6 (BOM option up to 8, eSIM BOM optional)	6 (BOM option up to 8, eSIM BOM optional)	8 (eSIM BOM optional)	2 (eSIM BOM optional)
WWAN	3 (BOM option up to 4)	3 (BOM option up to 4)	4	1
mini-PCIe Socket	- 1 x (USB 2.0, PCIe 2.0) - 1 x (USB 2.0, PCIe 2.0). BOM option to 1 x mini-PCIe (USB 2.0) for LTE - 1 x (USB 2.0) for LTE	- 1 x (USB 2.0, PCIe 2.0) - 1 x (USB 2.0, PCIe 2.0). BOM option to 1 x mini-PCIe (USB 2.0) for LTE - 1 x (USB 2.0) for LTE	- 1 x (USB 2.0, SATA 3.0/PCIe 3.0) - 1 x (USB 2.0, PCIe 3.0) for Wi-Fi. BOM option to 1 x M.2 3052 Key B (USB 2.0, USB 3.2 Gen 2x1) for LTE/5G*4	- 2 x (USB 2.0, PCIe 2.0) - 1 x (USB 2.0) for LTE - BOM option to 1 x M.2 3042 Key B (USB 2.0, USB 3.2 (Gen1)) for LTE/5G
M.2 Socket	- 1 x M.2 3042 Key B (USB 2.0, USB 3.2 (Gen 1))for LTE/5G - 1 x M.2 3042/3050/3052 Key B (USB 2.0, USB 3.2 (Gen 1)) for LTE/5G	- 1 x M.2 3042 Key B (USB 2.0, USB 3.2 (Gen 1))for LTE/5G - 1 x M.2 3042/3050/3052 Key B (USB 2.0, USB 3.2 (Gen 1)) for LTE/5G	- 2 x M.2 3042/3052 Key B (USB 2.0, USB 3.2) for LTE/5G - 1 x M.2 2230 Key E (PCIe 3.0 x 1, USB 2.0) for Wi-Fi	- 1 x M.2 3042 Key B (USB 2.0, USB 3.2 (Gen 1)) for LTE/5G (BOM optional)
GNSS	VIOB-GPS-02 module (u-blox NEO-M8N)	VIOB-GPS-02 module (u-blox NEO-M8N)	VIOB-GPS-06 module (u-blox NEO-M9N)	u-blox NEO-M8N onboard
Power Input	DC 24/36V (w/o isolation), DC 24/110V (w/ isolation, optional)	DC 24 (w/ isolation), DC 24/36V (w/o isolation, optional), DC 110V (w/ isolation, optional)	DC 24V (w/o isolation), DC 24/110V (w/ isolation, optional)	DC 24/36V (w/o isolation), DC 24/110V (w/ isolation, optional), external power kit, optional
Ingress Protection	N/A	IP65	N/A	N/A
Certification	CE, FCC Class A, UKCA, EN50155	CE, FCC Class A, UKCA, EN50155	CE, FCC Class A, UKCA, EN50155	CE, FCC Class A, UKCA, EN50155
Operating Temperature	-40°C to 70°C (OT4)	-40°C to 70°C (OT4)	-40°C to 70°C (OT4)	-40°C to 70°C (OT4)
TPM	TPM 2.0, optional	TPM 2.0, optional	TPM 2.0	TPM 2.0, optional
OS	Win 10 64-bit, Linux (Kernel 4.x)	Win 10 64-bit, Linux (Kernel 4.x)	Win 10, Win 11, Linux (Kernel 4.x)	Win 10 64-bit, Linux (Kernel 4.x)
Dimensions (mm)	260 x 196 x 70	260 x 198 x 70	260 x 196 x 70	260 x 196 x 66.5







Model			
	nROK 7251-7A	nROK 7251-7C4	nROK 7251-WI-7C4IP
System			
CPU	Intel® Core™ i7-9700TE, 8 Core, 3.8GHz	Intel® Core™ i7-9700TE, 8 Core, 3.8GHz	Intel® Core™ i7-9700TE, 8 Core, 3.8GHz
Chipset	Intel® Q370	Intel® Q370	Intel® Q370
Memory	2 x DDR4 2666 SO-DIMM, 8GB (default) up to 64GB	2 x DDR4 2666 SO-DIMM, 8GB (default) up to 64 GB	2 x DDR4 2666 SO-DIMM, 8GB (default) up to 64GB
Storage	2 x 2.5" SATA 3.0 SSD (removable, 15mm)	2 x 2.5" SATA 3.0 SSD (removable, 15mm)	2 x 2.5" SATA 3.0 SSD (removable, 15mm)
Second Storage	2 x mSATA (occupied mini-PCIe socket)	2 x mSATA (occupied mini-PCIe socket)	2 x mSATA (occupied mini-PCIe socket)
Video Out	1 x VGA, 1 x HDMI	1 x VGA, 1 x HDMI	1 x VGA
Audio	1 x Mic-in, 1 x Line-out (M8)	1 x Mic-in, 1 x Line-out (M8)	1 x Mic-in, 1 x Line-out (M8)
Ethernet	2 x Intel® 10/100/1000 (M12)	1 x Intel® 10/100/1000 (M12)	1 x Intel® 10/100/1000 (M12)
PoE	N/A	4 x M12 independent Intel® 10/100/1000 (802.3af/at), Total 60W	4 x M12 independent Intel® 10/100/1000 (802.3af/at), Total 60W
USB	1 x M12 with 2 x USB 2.0 signal, 4 x USB 3.2 (Gen2)	1 x M12 with 2 x USB 2.0 signal, 4 x USB 3.2 (Gen2)	1 x M12 with 2 x USB 2.0 signal, 4 x USB 3.2 (Gen2)
COM	2 x RS232 (Full), 1 x RS232 (Full)/422/485. (w/ isolation)	2 x RS232 (Full), 1 x RS232 (Full)/422/485. (w/ isolation)	2 x RS232 (Full), 1 x RS232 (Full)/422/485. (w/ isolation)
DIO	4 x DI, 4 x DO(w/ isolation)	4 x DI, 4 x DO(w/ isolation)	4 x DI, 4 x DO(w/ isolation)
CAN Bus	N/A	N/A	N/A
DC Output	N/A	N/A	N/A
SIM Socket	6 (BOM option up to 8, eSIM BOM optional)	6 (BOM option up to 8, eSIM BOM optional)	6 (BOM option up to 8, eSIM BOM optional)
WWAN	3 (BOM option up to 4)	3 (BOM option up to 4)	3 (BOM option up to 4)
mini-PCIe Socket	- 1 x (USB 2.0, PCIe 3.0/SATA 3.0) - 1 x (USB 2.0, PCIe 3.0/SATA 3.0). BOM option to 1 x mini-PCIe (USB 2.0) for LTE - 1 x (USB 2.0) for LTE. BOM option to 1 x M.2 3042 Key B (USB 2.0, USB 3.2 (Gen2)) for LTE/5G	- 1 x (USB 2.0, PCIe 3.0/SATA 3.0) - 1 x (USB 2.0, PCIe 3.0/SATA 3.0). BOM option to 1 x mini-PCIe (USB 2.0) for LTE - 1 x (USB 2.0) for LTE. BOM option to 1 x M.2 3042 Key B (USB 2.0, USB 3.2 (Gen2)) for LTE/5G	- 1 x (USB 2.0, PCIe 3.0/SATA 3.0) - 1 x (USB 2.0, PCIe 3.0/SATA 3.0). BOM option to 1 x mini-PCIe (USB 2.0) for LTE - 1 x (USB 2.0) for LTE. BOM option to 1 x M.2 3042 Key B (USB 2.0, USB 3.2 (Gen2)) for LTE/5G
M.2 Socket	- 2 x M.2 3042/3050/3052 Key B (USB 2.0, USB 3.2 (Gen2)) for LTE/5G	- 2 x M.2 3042/3050/3052 Key B (USB 2.0, USB 3.2 (Gen2)) for LTE/5G	- 2 x M.2 3042/3050/3052 Key B (USB 2.0, USB 3.2 (Gen2)) for LTE/5G
GNSS	VIOB-GPS-02 module (u-blox NEO-M8N)	VIOB-GPS-02 module (u-blox NEO-M8N)	VIOB-GPS-02 module (u-blox NEO-M8N)
Power Input	DC 24V (w/o isolation)	DC 24V (w/o isolation)	DC 24~110V (w/ isolation)
Ingress Protection	N/A	N/A	IP65
Certification	CE, FCC Class A, UKCA, EN50155	CE, FCC Class A, UKCA, EN50155	CE, FCC Class A, UKCA, EN50155
Operating Temperature	-40°C to 70°C (OT4)	-40°C to 70°C (OT4)	-40°C to 70°C (OT4)
TPM	TPM 2.0	TPM 2.0	TPM 2.0
OS	Win 10/11 64-bit, Linux (Kernel 4.x)	Win 10/11 64-bit, Linux (Kernel 4.x)	Win 10/11 64-bit, Linux (Kernel 4.x)
Dimensions (mm)	260 x 256 x 84	260 x 256 x 84	260 x 256 x 110





Railway Computer - Box PC

Model		
	nROK 7252-AC8S	nROK 7252-WI2-C8S
CPU	8/9th Gen Intel® Core™/Xeon® (AI Hailo-8™ onboard option)	8/9th Gen Intel® Core™/Xeon® (AI Hailo-8™ onboard option)
Chipset	Intel® C246	Intel® C246
Memory	2 x DDR4 2666 SO-DIMM, up to 64GB	2 x DDR4 2666 SO-DIMM, up to 64GB
Storage	4 x 2.5" SATA 3.0 SSD (removable, 15mm)	2 x 2.5" SATA 3.0 SSD (removable, 15mm)
Second Storage	2 x mSATA (occupied mini-PCIe socket) 1 x Removable SD 3.0	2 x mSATA (occupied mini-PCIe socket) 1 x Removable SD 3.0
Video Out	1 x VGA, 2 x HDMI	1 x VGA, 2 x HDMI
Audio	1 x Mic-in, 2 x Line-out (DB9)	1 x Mic-in, 2 x Line-out (DB9)
Ethernet	2 x Intel® 10/100/1000 (M12)	2 x Intel® 10/100/1000 (M12)
PoE	8 x M12 10/100/1000 (802.3af/at). Total 60W	8 x M12 10/100/1000 (802.3af/at). Total 60W
USB	1 x M12 with 2 x USB 2.0 signal, 4 x USB 3.2 (Gen2)	1 x M12 with 2 x USB 2.0 signal, 4 x USB 3.2 (Gen2)
COM	2 x RS232 (full), 1 x RS232 (full)/422/485. (w/ isolation)	2 x RS232 (full), 1 x RS232 (full)/422/485. (w/ isolation)
DIO	4 x DI, 4 x DO (w/ isolation)	4 x DI, 4 x DO (w/ isolation)
CAN Bus	1 x CAN Bus 2.0B (w/ isolation)	1 x CAN Bus 2.0B (w/ isolation)
DC Output	N/A	N/A
SIM Socket	6 (BOM option up to 8, eSIM BOM optional)	6 (BOM option up to 8, eSIM BOM optional)
WWAN	3 (BOM option up to 4)	3 (BOM option up to 4)
mini-PCIe Socket	- 1 x (USB 2.0, PCIe 3.0/SATA 3.0) - 1 x (USB 2.0, PCIe 3.0/SATA 3.0). BOM option to 1 x M.2 3042 Key B (USB 2.0, USB 3.2 (Gen1)) for LTE/5G - 1 x (USB 2.0) for LTE. BOM option to 1 x M.2 3042/3050/3052 Key B (USB 2.0, USB 3.2 (Gen2)) for LTE/5G	- 1 x (USB 2.0, PCIe 3.0/SATA 3.0) - 1 x (USB 2.0, PCIe 3.0/SATA 3.0). BOM option to 1 x M.2 3042 Key B (USB 2.0, USB 3.2 (Gen1)) for LTE/5G - 1 x (USB 2.0) for LTE. BOM option to 1 x M.2 3042/3050/3052 Key B (USB 2.0, USB 3.2 (Gen2)) for LTE/5G
M.2 Socket	- 2 x M.2 3042/3050/3052 Key B (USB 2.0, USB 3.2 (Gen2)) for LTE/5G	- 2 x M.2 3042/3050/3052 Key B (USB 2.0, USB 3.2 (Gen2)) for LTE/5G
GNSS	VIOB-GPS-02 module (u-blox NEO-M8N)	VIOB-GPS-02 module (u-blox NEO-M8N)
Power Input	DC 24/36V (w/o isolation)	DC 24~110V (w/ isolation, 3-second protection against temporary voltage dips)
Ingress Protection	N/A	N/A
Certification	CE, FCC Class A, UKCA, EN50155	CE, FCC Class A, UKCA, EN50155
Operating Temperature	-40°C to 70°C (OT4)	-40°C to 70°C (OT4)
TPM	TPM 2.0	TPM 2.0
OS	Win 10/11 64-bit, Linux (Kernel 4.x)	Win 10/11 64-bit, Linux (Kernel 4.x)
Dimensions (mm)	260 x 266 x 110	260 x 266 x 110





Model				
	nROK 7270-A	nROK 7270-AC4	nROK 7270-A-H	nROK 7270-AC4-C8S
CPU	12th/13th Gen Intel® Core™	12th/13th Gen Intel® Core™	12th/13th Gen Intel® Core™	12th/13th Gen Intel® Core™
Chipset	Intel® R680E	Intel® R680E	Intel® R680E	Intel® R680E
Memory	2 x DDR5 4800 SO-DIMM, up to 64GB, ECC support	2 x DDR5 4800 SO-DIMM, up to 64GB, ECC support	2 x DDR5 4800 SO-DIMM, up to 64GB, ECC support	2 x DDR5 4800 SO-DIMM, up to 64GB, ECC support
Storage	2 x 2.5" SATA 3.0 SSD (removable, 15mm)	2 x 2.5" SATA 3.0 SSD (removable, 15mm)	2 x 2.5" SATA 3.0 SSD (removable, 15mm)	2 x 2.5" SATA 3.0 SSD (removable, 15mm)
Second Storage	1 x mSATA (occupied mini-PCIe socket) 2 x M.2 Key B (occupied M.2 socket) 1 x microSD card slot, SDXC v3.01	1 x mSATA (occupied mini-PCIe socket) 2 x M.2 Key B (occupied M.2 socket) 1 x microSD card slot, SDXC v3.01	1 x mSATA (occupied mini-PCIe socket) 2 x M.2 Key B (occupied M.2 socket) 1 x microSD card slot, SDXC v3.01	1 x mSATA (occupied mini-PCIe socket) 2 x M.2 Key B (occupied M.2 socket) 1 x microSD card slot, SDXC v3.01
Video Out	1 x VGA, 1 x HDMI	1 x VGA, 1 x HDMI	1 x VGA, 1 x HDMI	1 x VGA, 1 x HDMI
Audio	1 x Mic-in, 1 x Line-out (M8)	1 x Mic-in, 1 x Line-out (M8)	1 x Mic-in, 1 x Line-out (M8)	1 x Mic-in, 1 x Line-out (M8)
Ethernet	2 x Intel® 10/100/1000/2500 (M12, WoL support)	1 x Intel® 10/100/1000/2500 (M12, WoL support)	2 x Intel® 10/100/1000/2500 (M12, WoL support)	1 x Intel® 10/100/1000/2500 (M12, WoL support)
PoE	N/A	4 x independent Intel® 2.5GbE (802.3at/af). Total 60W	N/A	4 x independent Intel® 2.5GbE (802.3at/af, total 60W) 8 x M12 Intel® 10/100/1000 (802.3af/at). Total 60W
USB	1 x M12 with 2 x USB 2.0 signal, 2 x USB 3.2 (Gen2)	1 x M12 with 2 x USB 2.0 signal, 2 x USB 3.2 (Gen2)	1 x M12 with 2 x USB 2.0 signal, 2 x USB 3.2 (Gen2)	1 x M12 with 2 x USB 2.0 signal, 2 x USB 3.2 (Gen2)
COM	2 x RS232 (Full)/422/485. (w/ isolation)	2 x RS232 (full)/422/485. (w/ isolation)	2 x RS232 (full)/422/485. (w/ isolation)	2 x RS232 (full)/422/485. (w/ isolation)
DIO	4 x DI, 4 x DO. (w/ isolation)	4 x DI, 4 x DO. (w/ isolation)	4 x DI, 4 x DO. (w/ isolation)	4 x DI, 4 x DO. (w/ isolation)
CAN Bus	2 x CAN FD (w/ isolation)	2 x CAN FD (w/ isolation)	2 x CAN FD (w/ isolation)	2 x CAN FD (w/ isolation)
DC Output	N/A	N/A	N/A	N/A
SIM Socket	4 (eSIM BOM optional)	4 (eSIM BOM optional)	8 (eSIM BOM optional)	4 (eSIM BOM optional)
WWAN	2	2	4	2
mini-PCIe Socket	- 1 x (USB 2.0, PCIe 3.0/SATA 3.0)	- 1 x (USB 2.0, PCIe 3.0/SATA 3.0)	- 1 x (USB 2.0, PCIe 3.0/SATA 3.0) - 1 x (USB 2.0, PCIe 3.0)	- 1 x (USB 2.0, PCIe 3.0/SATA 3.0)
M.2 Socket	- 2 x M.2 3042/3050/3052 Key B (USB 2.0, USB 3.2 (Gen2), SATA 3.0) for LTE/5G - 1 x M.2 2230 Key E (USB 2.0, PCIe 3.0 x2). BOM option to 1 x M.2 2230 Key E (USB 2.0, PCIe 3.0, PCIe 3.0)	- 2 x M.2 3042/3050/3052 Key B (USB 2.0, USB 3.2 (Gen2), SATA 3.0) for LTE/5G - 1 x M.2 2230 Key E (USB 2.0, PCIe 3.0 x2). BOM option to 1 x M.2 2230 Key E (USB 2.0, PCIe 3.0, PCIe 3.0) "	- 2 x M.2 3042/3050/3052 Key B (USB 2.0, USB 3.2 (Gen2), SATA 3.0) for LTE/5G - 2 x M.2 3042/3050/3052 Key B (USB 2.0, USB 3.2 (Gen1)) for LTE/5G - 1 x M.2 2230 Key E (USB 2.0, PCIe 3.0 x2). BOM option to 1 x M.2 2230 Key E (USB 2.0, PCIe 3.0, PCIe 3.0)	- 2 x M.2 3042/3050/3052 Key B (USB 2.0, USB 3.2 (Gen2), SATA 3.0) for LTE/5G - 1 x M.2 2230 Key E (USB 2.0, PCIe 3.0 x2). BOM option to 1 x M.2 2230 Key E (USB 2.0, PCIe 3.0, PCIe 3.0)
GNSS	VIOB-GPS-06 module (u-blox NEO-M9N)	VIOB-GPS-06 module (u-blox NEO-M9N)	VIOB-GPS-06 module (u-blox NEO-M9N)	VIOB-GPS-06 module (u-blox NEO-M9N)
Power Input	DC 24/36V (w/o isolation)	DC 24/36V (w/o isolation)	DC 24/36V (w/o isolation)	DC 24/36V (w/o isolation)
Ingress Protection	N/A	N/A	N/A	N/A
Certification	CE, FCC Class A, UKCA, EN50155	CE, FCC Class A, UKCA, EN50155	CE, FCC Class A, UKCA, EN50155	CE, FCC Class A, UKCA, EN50155
Operating Temperature	-35°C to 70°C (OT3)	-35°C to 70°C (OT3)	-35°C to 70°C (OT3)	-35°C to 70°C (OT3)
TPM	TPM 2.0	TPM 2.0	TPM 2.0	TPM 2.0
OS	Win 10/11 64-bit, Linux (Kernel 4.x)	Win 10/11 64-bit, Linux (Kernel 4.x)	Win 10/11 64-bit, Linux (Kernel 4.x)	Win 10/11 64-bit, Linux (Kernel 4.x)
Dimensions (mm)	260 x 210 x 80	260 x 210 x 80	260 x 210 x 80	260 x 210 x 80

Railway Computer - Box PC

	Coming soon	Coming soon	Coming soon
Model			
	nROK 7271-WI	nROK 7271-WIC4	nROK 7271-WI-H
CPU	Intel® Core™ 12th/13th Gen	Intel® Core™ 12th/13th Gen	Intel® Core™ 12th/13th Gen
Chipset	Intel® R680E	Intel® R680E	Intel® R680E
Memory	2 x DDR5 4800 SO-DIMM, up to 64GB, ECC support	2 x DDR5 4800 SO-DIMM, up to 64GB, ECC support	2 x DDR5 4800 SO-DIMM, up to 64GB, ECC support
Storage	2 x 2.5" SATA 3.0 SSD (removable, 15mm)	2 x 2.5" SATA 3.0 SSD (removable, 15mm)	2 x 2.5" SATA 3.0 SSD (removable, 15mm)
Second Storage	1 x mSATA (occupied mini-PCIe socket) 2 x M.2 Key B (occupied M.2 socket) 1 x microSD card slot, SDXC v3.01	1 x mSATA (occupied mini-PCIe socket) 2 x M.2 Key B (occupied M.2 socket) 1 x microSD card slot, SDXC v3.01	1 x mSATA (occupied mini-PCIe socket) 2 x M.2 Key B (occupied M.2 socket) 1 x microSD card slot, SDXC v3.01
Video Out	1 x VGA, 1 x HDMI	1 x VGA, 1 x HDMI	1 x VGA, 1 x HDMI
Audio	1 x Mic-in, 1 x Line-out (M8)	1 x Mic-in, 1 x Line-out (M8)	1 x Mic-in, 1 x Line-out (M8)
Ethernet	2 x Intel® 10/100/1000/2500 (M12, WoL support)	1 x Intel® 10/100/1000/2500 (M12, WoL support)	2 x Intel® 10/100/1000/2500 (M12, WoL support)
PoE	N/A	4 x Independent Intel® 2.5GbE (802.3at/af). Total 60W	N/A
USB	1 x M12 with 2 x USB 2.0 signal, 2 x USB 3.2 (Gen2)	1 x M12 with 2 x USB 2.0 signal, 2 x USB 3.2 (Gen2)	1 x M12 with 2 x USB 2.0 signal, 2 x USB 3.2 (Gen2)
COM	2 x RS232 (Full)/422/485. (w/ isolation)	2 x RS232 (Full)/422/485. (w/ isolation)	2 x RS232 (Full)/422/485. (w/ isolation)
DIO	4 x DI, 4 x DO. (w/ isolation)	4 x DI, 4 x DO. (w/ isolation)	4 x DI, 4 x DO. (w/ isolation)
CAN Bus	2 x CAN FD (w/ isolation)	2 x CAN FD (w/ isolation)	2 x CAN FD (w/ isolation)
DC Output	N/A	N/A	N/A
SIM Socket	4 (eSIM BOM optional)	4 (eSIM BOM optional)	8 (eSIM BOM optional)
WWAN	2	2	4
mini-PCIe Socket	- 1 x (USB 2.0, PCIe 3.0/SATA 3.0)	- 1 x (USB 2.0, PCIe 3.0/SATA 3.0)	- 1 x (USB 2.0, PCIe 3.0/SATA 3.0) - 1 x (USB 2.0, PCIe 3.0)
M.2 Socket	- 2 x M.2 3042/3050/3052 Key B (USB 2.0, USB 3.2 (Gen2), SATA 3.0) for LTE/5G - 1 x M.2 2230 Key E (USB 2.0, PCIe 3.0 x2). BOM option to 1 x M.2 2230 Key E (USB 2.0, PCIe 3.0, PCIe 3.0)	- 2 x M.2 3042/3050/3052 Key B (USB 2.0, USB 3.2 (Gen2), SATA 3.0) for LTE/5G - 1 x M.2 2230 Key E (USB 2.0, PCIe 3.0 x2). BOM option to 1 x M.2 2230 Key E (USB 2.0, PCIe 3.0, PCIe 3.0)	- 2 x M.2 3042/3050/3052 Key B (USB 2.0, USB 3.2 (Gen2), SATA 3.0) for LTE/5G - 2 x M.2 3042/3050/3052 Key B (USB 2.0, USB 3.2 (Gen1)) for LTE/5G - 1 x M.2 2230 Key E (USB 2.0, PCIe 3.0 x2). BOM option to 1 x M.2 2230 Key E (USB 2.0, PCIe 3.0, PCIe 3.0)
GNSS	VIOB-GPS-06 module (u-blox NEO-M9N)	VIOB-GPS-06 module (u-blox NEO-M9N)	VIOB-GPS-06 module (u-blox NEO-M9N)
Power Input	DC 24~110V (w/ isolation, optional 3-second protection against temporary voltage dips)	DC 24~110V (w/ isolation, optional 3-second protection against temporary voltage dips)	DC 24~110V (w/ isolation, optional 3-second protection against temporary voltage dips)
Ingress Protection	N/A	N/A	N/A
Certification	CE, FCC Class A, UKCA, EN50155	CE, FCC Class A, UKCA, EN50155	CE, FCC Class A, UKCA, EN50155
Operating Temperature	-35°C to 70°C (OT3)	-35°C to 70°C (OT3)	-35°C to 70°C (OT3)
TPM	TPM 2.0	TPM 2.0	TPM 2.0
OS	Win 10/11 64-bit, Linux (Kernel 4.x)	Win 10/11 64-bit, Linux (Kernel 4.x)	Win 10/11 64-bit, Linux (Kernel 4.x)
Dimensions (mm)	260 x 210 x 110	260 x 210 x 110	260 x 210 x 110

Railway Computer - Panel PC

	Coming soon
Model	
	nROK 7271-WIC4-C8S
CPU	Intel® Core™ 12th/13th Gen
Chipset	Intel® R680E
Memory	2 x DDR5 4800 SO-DIMM, up to 64GB, ECC support
Storage	2 x 2.5" SATA 3.0 SSD (removable, 15mm)
Second Storage	1 x mSATA (occupied mini-PCIe socket) 2 x M.2 Key B (occupied M.2 socket) 1 x microSD card slot, SDXC v3.01
Video Out	1 x VGA, 1 x HDMI
Audio	1 x Mic-in, 1 x Line-out (M8)
Ethernet	1 x Intel® 10/100/1000/2500 (M12, WoL support)
PoE	4 x Independent Intel® 2.5GbE (802.3at/af). Total 30W 8 x M12 Intel® 10/100/1000 (802.3at/af). Total 30W
USB	1 x M12 with 2 x USB 2.0 signal, 2 x USB 3.2 (Gen2)
COM	2 x RS232 (Full)/422/485. (w/ isolation)
DIO	4 x DI, 4 x DO. (w/ isolation)
CAN Bus	2 x CAN FD (w/ isolation)
DC Output	N/A
SIM Socket	4 (eSIM BOM optional)
WWAN	2
mini-PCIe Socket	- 1 x (USB 2.0, PCIe 3.0/SATA 3.0)
M.2 Socket	- 2 x M.2 3042/3050/3052 Key B (USB 2.0, USB 3.2 (Gen2), SATA 3.0) for LTE/5G - 1 x M.2 2230 Key E (USB 2.0, PCIe 3.0 x2). BOM option to 1 x M.2 2230 Key E (USB 2.0, PCIe 3.0, PCIe 3.0)
GNSS	VIOB-GPS-06 module (u-blox NEO-M9N)
Power Input	DC 24~110V (w/ isolation, optional 3-second protection against temporary voltage dips)
Ingress Protection	N/A
Certification	CE, FCC Class A, UKCA, EN50155
Operating Temperature	-35°C to 70°C (OT3)
TPM	TPM 2.0
OS	Win 10/11 64-bit, Linux (Kernel 4.x)
Dimensions (mm)	260 x 210 x 110

	vROK 3030
Model	
LCD Size	10.4" TFT LCD
Resolution	1024 x 768
Brightness (Typ.)	1200cd/m²
Contrast Ratio	900:1
View Angle	V: 85/85 H: 85/85
Brightness Adjustment	Auto via light sensor (BOM optional)
Touch Screen	Projected capacitive, anti-glare (BOM optional)
CPU	Intel Atom® x6414RE, 4 Core, 1.50GHz
Chipset	N/A
Memory	1 x DDR4 2666 SO-DIMM, 4GB (default) up to 32GB
Storage	1 x mSATA (occupied mini-PCIe socket) 1 x M.2 2280 Key M NVMe SSD (PCIe 3.0 x1, SATA 3.0)
Speaker	N/A
Control Button	BOM optional
Video Out	1 x HDMI, 1 x DP
Video Input	4 x CVBS
Audio	1 x Line-in, 2 x Line-out (DB9)
Ethernet	2 x Intel® 10/100/1000/2500 (M12)
PoE	Optional
USB	1 x M12 with 2 x USB 2.0 signal, 1 x USB 3.2 (Gen 2)
COM	2 x RS232 (Full)/422/485
DIO	4 x DI, 2 x DO (w/ isolation)
CAN Bus	1 x CAN Bus 2.0B
SIM Socket	2
WWAN	1
mini-PCIe Socket	1 x (USB 2.0, PCIe 3.0/SATA 3.0)
M.2 Socket	- 1 x M.2 2230 Key E (USB 2.0, PCIe 3.0, PCIe 3.0) - 1 x M.2 3042/3050/3052 Key B (USB 2.0, USB 3.2 (Gen 2)) for LTE/5G
GNSS	VIOB-GPS-06 module (u-blox NEO-M9N)
Power Input	DC 24/36V (w/o isolation) DC 24/110V (w/ isolation, optional)
Back Up Battery	N/A
Ingress Protection	N/A
Certification	CE, FCC Class A, UKCA, EN50155
Operating Temperature	-30°C to 70°C (OT3), w/o PoE -30°C to 60°C (OT1), w/ PoE
TPM	TPM 2.0
OS	Win 10/11 64-bit, Linux (Kernel 4.x)
Mounting	VESA 75
Dimensions (mm)	309 x 230.6 x 67.7



Vehicle Network Switch

VES Series Brief Product Introduction

Product Description

VES Series is the unmanaged mobile vehicle and railway PoE switch that ensures stable network service for telematics applications. Enclosed in a fanless rugged chassis, they support a wide voltage input range, fully

operable under shock, vibration, and a harsh temperature range. The reliable mobile vehicle and railway PoE switch is certified with E-Mark and EN50155.

 EN50155 and E-Mark certification

 M12 X-coded LAN connector

 -40~70°C operating temperature

 Compact and ruggedized enclosure design

Application

- Video surveillance
- Wireless gateway
- Passenger infotainment system

Product Highlight



Dedicated for onboard vehicle/train systems

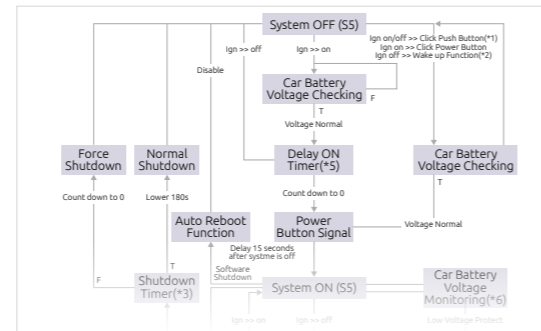





Ignition power management: power on/off delay, wide voltage input 9~36VDC, low voltage protection



Ultra-rugged enclosure, comply with MIL-STD-810H against vibration and shock impact



Rich 4/8-port IEEE 802.3af/at compliant PoE, up to 30W/port

	NEW	NEW	NEW	NEW
Model	 VES31-4S	 VES31-8S	 VES31-4SR	 VES31-8SR
Architecture	Unmanaged GbE switch	Unmanaged GbE switch	Unmanaged GbE switch	Unmanaged GbE switch
PoE	4 x 10/100/1000 (w/ 802.3af/at). Total 120W.	8 x 10/100/1000 (w/ 802.3af/at). Total 120W.	4 x M12 10/100/1000 (w/ 802.3af/at). Total 120W.	8 x M12 10/100/1000 (w/ 802.3af/at). Total 120W.
Ethernet	2 x 10/100/1000	2 x 10/100/1000	2 x 10/100/1000 (M12)	2 x 10/100/1000 (M12)
LED	1 x Power indicator 4 x PoE indicator 1 x Low voltage protection indicator 8 x Active/link indicator	1 x Power indicator 8 x PoE indicator 1 x Low voltage protection indicator 12 x Active/link indicator	1 x Power indicator 4 x PoE indicator 1 x Low voltage protection indicator 6 x Active/link indicator	1 x Power indicator 8 x PoE indicator 1 x Low voltage protection indicator 10 x Active/link indicator
Power Input	DC 9V to 36V	DC 9V to 36V	DC 9V to 36V	DC 9V to 36V
Certification	CE, FCC Class B, UKCA, E13	CE, FCC Class B, UKCA, E13	CE, FCC Class B, UKCA, EN50155	CE, FCC Class B, UKCA, EN50155
Operating Temperature	-40°C to 70°C	-40°C to 70°C	-40°C to 70°C (OT4)	-40°C to 70°C (OT4)
Dimensions (mm)	167 x 140 x 52	167 x 140 x 52	167 x 140 x 85	167 x 140 x 85



Vehicle Mount Computer and Display

VMC and VMD Series Brief Product Introduction

Product Description

The VMC series is a durable vehicle mount computer suitable for warehouse, ports, logistics, and material handling markets. Its IP65 rating protects against water/dust damage and its sunlight readability ensures display visibility. Optional back-up battery preserves data when car power battery fails, while wide-range power input (9~60VDC) allows for use in various facilities, forklifts, and

vehicles. The VMD series is a tough TFT LCD monitor with a resistant or projected capacitive touchscreen, ideal for in-vehicle use. Its high-brightness display and automatic brightness control make it suitable for use in various lighting conditions. With an IP65 rating it is protected against water/dust damage, and its over 1000 nits display ensures excellent visibility.

 Full IP65 compliance

 5G/LTE, Wi-Fi 6/6E, BT, CAN/OBD, GNSS + DR, and multi-SIM integration

 Vibration and shock resistant

 E-Mark certification

Application

- Fleet management
- Warehouse management
- Port management applications

Product Highlight



Wide range power input 9~60VDC



Back-up battery provides uninterrupted power





Sunlight readability & high brightness







Impact protection IK08

Vehicle Mount Computer

Model				
	VMC 110/111	VMC 1100	VMC 220-PC1	
Display	LCD Size	7" TFT LCD	7" TFT LCD	8" TFT LCD
	Resolution	1024 x 600	800 x 480	1280 x 720
	Brightness (Typ.)	500cd/m²	400cd/m²	1000cd/m²
	Contrast Ratio	800:1	600:1	1000:1
	View Angle	V: 70/75 H: 75/75	V: 50/70 H: 70/70	V: 85/85 H: 85/85
System	Brightness Adjustment	Auto via light sensor	Auto via light sensor	Auto via light sensor
	Touch Screen	4-wire resistive, anti-glare	4-wire resistive, anti-glare	Projected capacitive, anti-glare
	CPU	NXP i.MX6 Dual Lite, 2 Core, 800 MHz	Intel Atom® E3825, 2 Core, 1.33GHz	NXP i.MX 8M, 4 Core, 1.3 GHz
	Chipset	N/A	N/A	N/A
	Memory	1 x 2GB DDR3L onboard	1 x DDR3L 1600 SO-DIMM, 2GB (default) up to 8GB	1 x LPDDR4 2400 SDRAM 3GB onboard
I/O Interface	Storage	1 x eMMC 8GB 1 x Micro SD	1 x SATA 3.0 SATA DOM 3.0	1 x eMMC 32GB 1 x Micro SD
	Speaker	2 x Built-in speaker	2 x Built-in speaker	2 x Built-in speaker
	Control Button	F1~ F5 function key 1 x Power button 2 x Brightness/volume control 1 x System reset button	F1~ F5 function key 1 x Power button 2 x Brightness/volume control 1 x System reset button	F1~ F4 function key (2 x brightness/ 2 x volume control) 1 x Power button 1 x System reset button
	Video Out	N/A	N/A	N/A
	Video Input	N/A	N/A	4 x CVBS
Expansion	Audio	1 x Mic-in, 1 x Line-out	1 x Mic-in, 1 x Line-out	1 x Mic-in, 1 x Line-out
	Ethernet	1 x Intel® 10/100/1000	1 x Intel® 10/100/1000	1 x Intel® 10/100/1000 (M12)
	PoE	N/A	N/A	N/A
	USB	3 x USB 2.0	1 x USB 3.2 (Gen1)	3 x USB 2.0
	COM	1 x RS232 (Full), 1 x RS232 (Tx, Rx)/485	1 x RS232 (Full), 1 x RS232 (Tx, Rx) or 1 x RS485	1 x RS232 (Full), 1 x RS232 (Tx, Rx), 1 x RS232 (Tx, Rx)/RS422/RS485
Environment	DIO	3 x DI, 3 x DO	2 x PWM, 2 x AI, 2 x DI, 2 x DO	1 x PWM, 1 x Direction, 2 x DI, 2 x DO
	CAN Bus	2 x CAN Bus 2.0B	2 x CAN Bus 2.0B	1 x CAN Bus 2.0B (w/ isolation)
	SIM Socket	1	1	2
	WWAN	1	1	1
	mini-PCIe Socket	1 x (USB 2.0, PCIe 2.0) 1 x (USB 2.0) for LTE	1 x (USB 2.0, PCIe 2.0) 1 x (USB 2.0) for LTE	N/A
Others	M.2 Socket	N/A	N/A	- 1 x M.2 2230 Key E (PCIe 2.0, SDIO 3.0, UART) - 1 x M.2 3042/3050/3052 Key B (USB 3.2 (Gen1)) for LTE/5G
	GNSS	Onboard u-blox NEO-M8N	Onboard u-blox NEO-M8N	VI0B-GPS-02 module (u-blox NEO-M8N)
	Power Input	DC 9V to 36V	DC 9V to 36V	DC 9V to 60V
	Back Up Battery	N/A	N/A	N/A
	Ingress Protection	Front panel IP54	Front panel IP54	IP65
Certification	Certification	CE, FCC Class B, UKCA, E13	CE, FCC Class B, UKCA, E13, SAE J1113, SAE J1455, ISO7637-2, EN 60950-1 LVD	CE, FCC Class B, UKCA, E13, IK08
	Operating Temperature	-20°C to 70°C	-20°C to 60°C	-40°C to 70°C
	TPM	N/A	N/A	TPM 2.0, optional
OS	OS	Android 5.1	Win 10 64-bit, Win 8, WES8, Win 7, WES 7, Linux (Kernel 4.x)	Linux
	Mounting	VESA 75	VESA 75	VESA 75
Dimensions (mm)	213 x 145 x 40	213 x 145 x 50	250 x 179 x 68	



Vehicle Mount Computer

		Coming soon		
Model				
		VMC 320-AC0	VMC 2020-PC1	VMC 3020
Display	LCD Size	10.1" TFT LCD	8" TFT LCD	10.4" TFT LCD
	Resolution	1280 x 800	1280 x 720	1024 x 768
	Brightness (Typ.)	1000cd/m ²	1000cd/m ²	1200cd/m ²
	Contrast Ratio	800:1	1000:1	900:1
	View Angle	V: 85/85 H: 85/85	V: 85/85 H: 85/85	V: 85/85 H: 85/85
System	Brightness Adjustment	Auto via light sensor	Auto via light sensor	Auto via light sensor
	Touch Screen	Projected capacitive, anti-glare	Projected capacitive, anti-glare	5-wire resistive, anti-glare
	CPU	NXP i.MX 8M Plus, 4 Core, 1.6GHz	Intel Atom® x7-E3950, 4 Core, 2.0GHz	Intel Atom® x5-E3930, 4 Core, 1.3GHz
System	Chipset	N/A	N/A	N/A
	Memory	1 x LPDDR4 2133 SDRAM 3GB onboard	1 x DDR3L 1866 SO-DIMM, 4GB (default) up to 8GB	1 x DDR3L 1866 SO-DIMM slot 4GB (default) up to 8GB
	Storage	1 x eMMC 16GB 1 x Micro SDXC	1 x eMMC 64GB 1 x mSATA (occupied mini-PCIe socket)	1 x CFast 1 x 2.5" SATA 3.0 SSD bay (9.5mm)
I/O Interface	Speaker	2 x Built-in speaker	2 x Built-in speaker	2 x Built-in speaker
	Control Button	F1~ F5 function key (2 x brightness/ 2 x volume control, 1 x mute)	F1~ F4 function key (2 x brightness/ 2 x volume control) 1 x Power button 1 x System reset button	1 x Power button 2 x Brightness control 2 x Volume control 5 x Function key 1 x Shift key
	Video Out	1 x HDMI	N/A	N/A
	Video Input	N/A	4 x CVBS (optional)	N/A
	Audio	1 x Mic-in, 1 x Line-out	1 x Mic-in, 1 x Line-out	1 x Mic-in, 1 x Line-out
	Ethernet	1 x Intel® 10/100/1000 (M12)	1 x Intel® 10/100/1000 (M12)	1 x Intel® 10/100/1000
	PoE	N/A	N/A	N/A
	USB	2 x USB 2.0 1 x USB 3.2 (Gen1)	1 x USB 3.2 (Gen1) 2 x USB 2.0 1 x RS232 (full), 1 x RS232 (Tx, Rx), 1 x RS232 (Tx, Rx)/RS422/RS485	2 x USB 2.0 (5V/1.0A) 1 x Power USB (5V/1.5A, 12V/1.5A)
	COM	2 x RS232 (full)/422/485	1 x RS232 (full), 1 x RS232 (Tx, Rx), 1 x RS232 (Tx, Rx)/RS422/RS485	2 x Powered RS232 (full, 5V/1.5A, 12V/1.5A)
	DIO	2 x DI, 2 x DO	1 x PWM, 1 x Direction, 2 x DI, 2 x DO	2 x DI, 2 x DO
	CAN Bus	1 x CAN FD (w/ isolation)	1 x CAN Bus 2.0B (w/ isolation)	1 x CAN Bus 2.0B (w/ isolation)
	SIM Socket	2	2	2
	WWAN	1	1	1
	mini-PCIe Socket	N/A	1 x (USB 2.0, PCIe 2.0) 1 x (USB 2.0, PCIe 2.0/SATA 3.0)	1 x (USB 2.0, PCIe 2.0) 1 x (USB 2.0) for LTE
	Expansion	M.2 Socket	- 1 x M.2 2230 Key E (USB 2.0, PCIe 3.0) - 1 x M.2 3042/3050/3052 Key B (USB 3.2 (Gen1)) for LTE/5G	- 1 x M.2 3042/3050/3052 Key B (USB2.0, USB 3.2 (Gen1)) for LTE/5G
GNSS		VIOB-GPS-06 module (u-blox NEO-M9N)	VIOB-GPS-02 module (u-blox NEO-M8N)	Optional
Environment	Power Input	DC 9V to 60V	DC 9V to 60V	DC 9V to 60V
	Back Up Battery	Optional	N/A	Optional
	Ingress Protection	Front panel IP65	IP65	Front panel IP65
	Certification	CE, FCC Class B, UKCA, E13, IK08	CE, FCC Class B, UKCA, E13, IK08	CE, FCC Class B, UKCA, E13
Others	Operating Temperature	-30°C to 70°C	-30°C to 60°C	-30°C to 60°C
	TPM	TPM 2.0	TPM 2.0, optional	N/A
	OS	Linux, Android 13.0 (Q1, 2024)	Win 10 64-bit, Linux (Kernel 4.x)	Win 10 64-bit, Linux (Kernel 4.x)
Mounting	VESA 75/100	VESA 75	VESA 75/100	
Dimensions (mm)	294 x 227.5 x 37.2	250 x 179 x 68	290 x 230 x 68	





		Coming soon			
Model					
		VMC 3021	VMC 3030-AC0	VMC 4020-4A0	VMC 4020-4A1
Display	LCD Size	10.4" TFT LCD	10.1" TFT LCD	12.1" TFT LCD	12.1" TFT LCD
	Resolution	1024 x 768	1280 x 800	1024 x 768	1024 x 768
	Brightness (Typ.)	1200cd/m ²	1000cd/m ²	1200cd/m ²	1200cd/m ²
	Contrast Ratio	900:1	800:1	750:1	750:1
	View Angle	V: 85/85 H: 85/85	V: 85/85 H: 85/85	V: 85/85 H: 85/85	V: 85/85 H: 85/85
System	Brightness Adjustment	Auto via light sensor	Auto via light sensor	Auto via light sensor	Auto via light sensor
	Touch Screen	5-wire resistive, anti-glare	Projected capacitive, anti-glare	5-wire resistive, anti-glare	5-wire resistive, anti-glare
	CPU	Intel Atom® x7-E3950, 4 Core, 2.0GHz	Intel Atom® x7425E, 4 Core, 3.4GHz	Intel Atom® x7-E3950, 4 Core, 2.0GHz	Intel Atom® x7-E3950, 4 Core, 2.0GHz
System	Chipset	N/A	N/A	N/A	N/A
	Memory	1 x DDR3L 1866 SO-DIMM slot 4GB (default) up to 8GB	1 x DDR5 4800 SO-DIMM slot 4GB (default) up to 16GB	1 x DDR3L 1866 SO-DIMM slot 4GB (default) up to 8GB	1 x DDR3L 1866 SO-DIMM slot 4GB (default) up to 8GB
	Storage	1 x CFast 1 x 2.5" SATA 3.0 SSD bay (9.5mm)	1 x M.2 2280 Key M 1 x Micro SDXC (BOM optional)	1 x CFast 1 x 2.5" SATA 3.0 SSD bay (9.5mm)	1 x CFast 1 x 2.5" SATA 3.0 SSD bay (9.5mm)
I/O Interface	Speaker	2 x Built-in speaker	2 x Built-in speaker	2 x Built-in speaker	2 x Built-in speaker
	Control Button	1 x Power button 2 x Brightness control 2 x Volume control 5 x Function key 1 x Shift key	F1~ F5 function key (2 x brightness/ 2 x volume control, 1 x mute) 1 x Power button 1 x System reset button	1 x Power button 2 x Brightness control 2 x Volume control 5 x Function key 1 x Shift key	1 x Power button 2 x Brightness control 2 x Volume control 5 x Function key 1 x Shift key
	Video Out	N/A	1 x HDMI	N/A	N/A
	Video Input	3 x CVBS	N/A	3 x CVBS	3 x CVBS
	Audio	1 x Mic-in, 1 x Line-out	1 x Mic-in, 1 x Line-out	1 x Mic-in, 1 x Line-out	1 x Mic-in, 1 x Line-out
	Ethernet	1 x Intel® 10/100/1000 (M12)	1 x Intel® 10/100/1000/2500 (M12)	2 x Intel® 10/100/1000	2 x Intel® 10/100/1000 (M12)
	PoE	1 x (802.3af/at). Total 30W (optional)	N/A	1 x (802.3af/at). Total 30W (optional)	1 x (802.3af/at). Total 30W (optional)
	USB	2 x USB 2.0	1 x USB 2.0 2 x USB 3.2 (Gen2)	2 x USB 2.0	2 x USB 2.0
	COM	1 x RS232 (full)/422/485, 1 x RS232 (Tx, Rx)/422/485	2 x RS232 (full)/422/485	2 x RS232 (full)/422/485	1 x RS232 (full)/422/485, 1 x RS232 (Tx, Rx)/422/485
	DIO	2 x DI, 2 x DO	2 x DI, 2 x DO	2 x DI, 2 x DO	2 x DI, 2 x DO
	CAN Bus	2 x CAN Bus 2.0B (w/ isolation)	1 x CAN FD (w/ isolation)	2 x CAN Bus 2.0B (w/ isolation)	2 x CAN Bus 2.0B (w/ isolation)
	SIM Socket	2	2	2	2
	WWAN	1	1	1	1
	mini-PCIe Socket	3 x (USB 2.0, PCIe 2.0) 1 x (USB 2.0) for LTE	1 x (USB 2.0, PCIe 3.0/SATA 3.0)	3 x (USB 2.0, PCIe 2.0) 1 x (USB 2.0) for LTE	3 x (USB 2.0, PCIe 2.0) 1 x (USB 2.0) for LTE
	Expansion	M.2 Socket	N/A	- 1 x M.2 3042/3050/3052 Key B (USB 2.0, USB 3.2 (Gen2)) for LTE/5G - 1 x M.2 2230 Key E (USB 2.0, PCIe 3.0 x2). BOM option to - 1 x M.2 2230 Key E (USB 2.0, PCIe 3.0, PCIe 3.0)	N/A
GNSS		VIOB-GPS-02 module (u-blox NEO-M8N)	VIOB-GPS-06 module (u-blox NEO-M9N)	VIOB-GPS-02 module (u-blox NEO-M8N)	VIOB-GPS-02 module (u-blox NEO-M8N)
Environment	Power Input	DC 9V to 60V	DC 9V to 60V	DC 9V to 60V	DC 9V to 60V
	Back Up Battery	Optional	Optional	Optional	Optional
	Ingress Protection	IP65	Front panel IP65	Front panel IP65	IP65
	Certification	CE, FCC Class B, UKCA, E13	CE, FCC Class B, UKCA, E13, IK08	CE, FCC Class B, UKCA, E13	CE, FCC Class B, UKCA, E13
Others	Operating Temperature	-30°C to 60°C	-30°C to 60°C	-30°C to 60°C	-30°C to 60°C
	TPM	N/A	TPM 2.0	N/A	N/A
	OS	Win 10 64-bit, Linux (Kernel 4.x)	Win 10/11 64-bit, Linux (Kernel 4.x)	Win 10 64-bit, Linux (Kernel 4.x)	Win 10 64-bit, Linux (Kernel 4.x)
Mounting	VESA 75/100	VESA 75/100	VESA 75/100	VESA 75/100	
Dimensions (mm)	290 x 230 x 68	294 x 227.5 x 54	340 x 262 x 75	340 x 262 x 75	



Vehicle Mount Display

Model			
	VMD 1001	VMD 2000	VMD 2002
LCD Size	7" TFT LCD	8" TFT LCD	8" TFT LCD
Resolution	800 x 480	800 x 600	800 x 600
Brightness (Typ.)	500cd/m²	400cd/m²	400cd/m²
Contrast Ratio	600:1	500:1	500:1
View Angle	V: 60/60 H: 70/70	V: 50/70 H: 70/70	V: 50/70 H: 70/70
Brightness Adjustment	Auto via light sensor	Auto via light sensor	Auto via light sensor
Touch Screen	4-wire resistive, anti-glare	4-wire resistive, anti-glare	4-wire resistive, anti-glare
Speaker	2 x Built-in speaker	2 x Built-in speaker	2 x Built-in speaker
Camera	N/A	N/A	N/A
Control Button	1 x Monitor power button 2 x Brightness control 2 x Volume control	1 x Monitor power button 2 x Brightness control 2 x Volume control	1 x Monitor power button 2 x Brightness control 2 x Volume control
Video Input	VGA	Integrated LVDS CONN (LVDS, USB, 12V)	Integrated DVI CONN (VGA, USB, 12V)
Audio	1 x Line-in (lateral side) 1 x Line-out (lateral side)	1 x Line-out (lateral side) 1 x Mic-in (lateral side) 1 x Line-in (bottom side) 1 x Mic-out (bottom side)	1 x Line-out (lateral side) 1 x Mic-in (lateral side) 1 x Line-in (bottom side) 1 x Mic-out (bottom side)
USB	2 x USB 2.0	1 x USB 2.0	1 x USB 2.0
Remote Power Button	N/A	Remotely power on/off VTC, MVS & ATC	N/A
Power Input	DC 9V to 36V	DC 12V (via LVDS)	DC 9V to 36V
Ingress Protection	Front panel IP54	Front panel IP54	Front panel IP54
Certification	CE, FCC Class B, UKCA	CE, FCC Class B, UKCA	CE, FCC Class B, UKCA
Operating Temperature	-20°C to 70°C	-20°C to 60°C	-20°C to 60°C
Mounting	VESA 75	VESA 75	VESA 75
Dimensions (mm)	182 x 138 x 36.3	207 x 173 x 36.7	207 x 173 x 36.7







Model			
	VMD 2003	VMD 3002-BS2	VMD 3110
LCD Size	8" TFT LCD	10.4" TFT LCD	10.4" TFT LCD
Resolution	800 x 600	1024 x 768	1024 x 768
Brightness (Typ.)	1000cd/m²	1200cd/m²	1200cd/m²
Contrast Ratio	500:1	900:1	900:1
View Angle	V: 60/60 H: 70/70	V: 85/85 H: 85/85	V: 85/85 H: 85/85
Brightness Adjustment	Auto via light sensor	Auto via light sensor	Auto via light sensor
Touch Screen	4-wire resistive, anti-glare	Projected capacitive	Projected capacitive
Speaker	2 x Built-in speaker	2 x Built-in speaker	2 x Built-in speaker
Camera	N/A	N/A	N/A
Control Button	1 x Monitor power button 2 x Brightness control 2 x Volume control	1 x Monitor power button 1 x OSD menu 2 x Brightness control 2 x Volume control 1 x Auto config	1 x Monitor power button 1 x OSD menu 2 x Brightness control 2 x Volume control 1 x Auto config
Video Input	ultraONE+, 4 x CVBS	VGA, 4 x CVBS	ultraONE+, 4 x CVBS
Audio	1 x Line-out (lateral side) 1 x Mic-in (lateral side)	1 x Line-in	1 x Line-in
USB	1 x USB 2.0	1 x USB 2.0	1 x USB 2.0
Remote Power Button	Remotely power on/off VTC, MVS & ATC	N/A	Remotely power off VTC, MVS & ATC
Power Input	DC 24V (via ultraONE+)	DC 9V to 36V	DC 24V (via ultraONE+)
Ingress Protection	Front panel IP54	IP65	IP65
Certification	CE, FCC Class B, UKCA	CE, FCC Class B, UKCA	CE, FCC Class B, UKCA
Operating Temperature	-20°C to 60°C	-20°C to 60°C	-20°C to 60°C
Mounting	VESA 75	VESA 75/100	VESA 75/100
Dimensions (mm)	207 x 173 x 36.7	256.5 x 202.1 x 31.5	256.5 x 202.1 x 31.5







Add-on Modules and Devices

Model					
Description	CANBus 2.0B or OBD SAE J1939 module	Dual CANBus 2.0B module	SAE J1708 module	OBD SAE J1939 module	mini-PCIe to M.2 converter module
I/O Interface					
Input I/F	UART	USB 2.0	USB 2.0	USB 2.0	USB 2.0, PCIe 3.0
Input Connector	2 x 5-pin wafer	mini-PCIe Socket	mini-PCIe Socket or USB wafer	mini-PCIe Socket or USB wafer	mini-PCIe
Output I/F	CANBus 2.0B or OBD SAE J1939	CANBus 2.0B	SAE J1708/J1587/J1922	OBD SAE J1939	M.2 2230 Key E
Output Connector	2 x 5-pin wafer	6-pin wafer to DB9	3-pin wafer to DB9	3-pin wafer to DB9	M.2 (socket)
Operating Temperature	-40°C to 85°C	-40°C to 85°C	-40°C to 85°C	-40°C to 85°C	-40°C to 85°C
Environment/ Others					
Form Factor	Proprietary	Full-size mini-PCIe	Full-size mini-PCIe	Full-size mini-PCIe	Full-size mini-PCIe
Dimensions (mm)	50 x 28	51 x 30	51 x 30	51 x 30	51 x 30
Remark	CANBus 2.0B & SAE J1939 election by switch	-	-	-	-



Model				
Description	u-blox M8N module	u-blox M9N module	u-blox M8L module	u-blox M9V module
I/O Interface				
Input I/F	UART	UART	UART	USB/UART
Input Connector	6-pin wafer	6-pin wafer	6-pin wafer	6-pin wafer
Output I/F	UART	UART	UART	USB/UART
Output Connector	6-pin wafer	6-pin wafer	6-pin wafer	6-pin/8-pin wafer
Operating Temperature	-40°C to 85°C	-40°C to 85°C	-40°C to 85°C	-40°C to 85°C
Environment/ Others				
Form Factor	Proprietary	Proprietary	Proprietary	Proprietary
Dimensions (mm)	25.4 x 25.4	25.4 x 25.4	25.4 x 25.4	25.4 x 25.4
Remark	Baud Rate: 9600. u-blox NEO-M8N GNSS supports with GPS + QZSS, GLONASS, Galileo and BeiDou. 3 of concurrent GNSS	Baud Rate: 38400. u-blox NEO-M9N GNSS supports with GPS + QZSS/SBAS, GLONASS, Galileo and BeiDou. 4 of concurrent GNSS	- Baud Rate: 9600. u-blox NEO-M8L-06B GNSS support with GPS, GLONASS, Galileo, BeiDou and QZSS - Automotive Dead Reckoning (ADR) - With battery	- Baud Rate: 38400. u-blox NEO-M9V-20B GNSS supports with GPS, GLONASS, Galileo, BeiDou and QZSS - Support ADR and UDR - With battery



Model					
Description	M.2 to mini-PCIe converter module	mini-PCIe to M.2 converter module	2 x Mic-in & 2 x Line-out module	Dual port 10GbE module with SFP+ for aROK 5510	External attachable power isolation kit VTK 6222-APK: 24VDC VTK 6222-FPK: 110VDC
I/O Interface					
Input I/F	USB 2.0, USB 3.0	USB 2.0, USB 3.2 (Gen1)	USB 2.0	PCIe 3.0	VTK 6222-APK: 24VDC VTK 6222-FPK: 110VDC
Input Connector	M.2 Key B + M	mini-PCIe	mini-PCIe Socket or USB wafer	PCIe 3.0 x8	M12 (5-pin)
Output I/F	mini-PCIe	M.2 3042/3050/3052 Key B	2 x Mic-in 2 x Line-out	Dual port SFP+, 10/1GbE	24VDC
Output Connector	mini-PCIe (socket)	M.2 (socket)	1 x 10-pin wafer to DB15	2 x SFP+	M12 (5-pin)
Operating Temperature	-40°C to 85°C	-40°C to 85°C	-40°C to 85°C	-40°C~70°C	-40°C to 70°C
Environment/ Others					
Form Factor	M.2 3042/3052 Key B + M	Full-Size mini-PCIe	Full-size mini-PCIe	Proprietary	Proprietary
Dimensions (mm)	62 x 31	65 x 30	51 x 30	96.7 x 181.5 x 37.4	120 (W) x 198 (D) x 50 (H)
Remark	Only for LTE module	USB 3.2 (Gen1) depended by airbord	-	Only for aROK 5510	Only for nROK 6222



Model				
Description	Vehicle relay module	External attachable power isolation kit	Smart backup battery kit	Smart UPS with SuperCap
I/O Interface				
Input I/F	USB 2.0 or RS-232 (Tx/Rx)	24VDC	9~36VDC	9~60VDC
Input Connector	USB type A or DB9	M12 (5-pin)	3-pin terminal block	5-pin terminal block
Output I/F	4 x Relay 4 x DI 4 x DO 1 x Analog input 1 x Frequency input	24VDC	10~12VDC (from backup battery) 9~36VDC (from vehicle battery) Communication: RS232/SMBus	12/24VDC (from backup SuperCap) 9~60VDC (from vehicle battery) Communication: RS232
Output Connector	Terminal block	M12 (5-pin)	Power: 3 Pin terminal block Communication: 2 x 5-pin	Power: 6 Pin terminal block Communication: DB9
Operating Temperature	-40°C to 85°C	-40°C to 70°C	Charging: 0°C to 45°C Discharging: 0°C to 55°C	Charging: -35°C to 80°C Discharging: -40°C to 80°C
Environment/ Others				
Form Factor	Proprietary	Proprietary	Proprietary	Proprietary
Dimensions (mm)	126 (W) x 124 (D) x 24 (H)	213 x 167 x 40	1). 280 (W) x 150 (D) x 42.2 (H) 2). 297.3 (W) x 175 (D) x 39 (H)	235 (W) x 134.5 (D) x 50 (H)
Remark	It is remotely controlled through USB or RS-232 communication	- VTK PWA20-01 for ATC 3750-C6 - VTK PWA10-01 for ATC 3540-IP7-C4	Capacity: 9000 mAh (Li-Ion) 60W output	- Nominal 24V@8A max (200W, 1 x master + 3 x slave) - For in-vehicle VTK-SCAP-M (master), VTK-SCAP-S (slave) - For Railway VTK-SCAP-AR-M (master), VTK-SCAP-S (slave)



HDMI over IP Extender

VIP Series Brief Product Introduction

Product Description

VIP Series is a new E-Mark certified in-vehicle HDMI extender over IP solution designed with 9~36VDC wide voltage input range, specifically for railway and bus public transport Passenger infotainment System.

VIP Series works over standard networking devices with wide operating temperature support, and outputs to multiple Full HD HDMI displays up to 100m.

 Wide-range 9-36Vdc input voltage

 Unicast and daisy chain support

 E-Mark for in-vehicle application

 Dual Full HD HDMI output

Application

- Video on demand
- Passenger infotainment system

Product Highlight



Dedicated for in-vehicle & railway PIS application

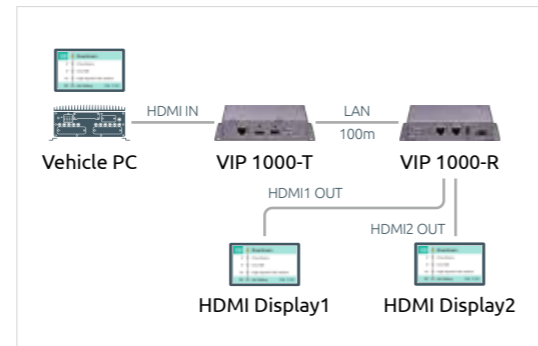

Support dual Full HD HDMI output + Up to 100 meter distance

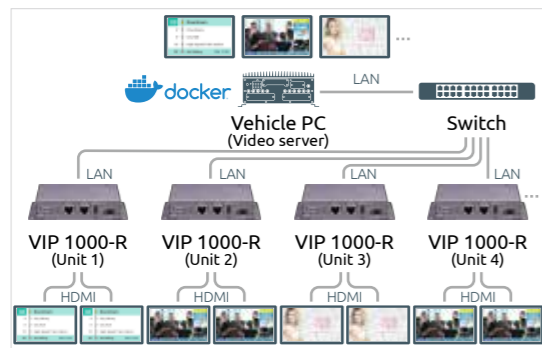

RTSP video on demand with Docker platform



Easy to use. Plug and play!

	 NEW	 NEW
	VIP 1000-T	VIP 1000-R
Model	Transmitter	Receiver
Function	Transmitter	Receiver
Video In	1 x FHD HDMI Type A	1 x 10/100/1000
Video Out	1 x 10/100/1000	2 x FHD HDMI Type A
Protocol	TCP/IP	TCP/IP
Model	Unicast, daisy chain and multicast mode	Unicast, daisy chain and multicast mode
USB	1 x USB 2.0 OTG	1 x USB 2.0
Ethernet	1 x 10/100/1000	2 x 10/100/1000 LAN switch
Power Input	DC 9V to 36V	DC 9V to 36V
Ignition Control	Yes	Yes
Certification	CE, FCC Class A, UKCA, E13	CE, FCC Class A, UKCA, E13
Operating Temperature	-20°C to 70°C	-20°C to 70°C
Dimensions (mm)	130 x 100 x 31	130 x 100 x 31



About NEXCOM

Reliable Partner for the AIoT Digital Transformation Solutions

Committed to Customer Success

Founded in 1992 and headquartered in Taipei, Taiwan, NEXCOM is committed to being a trustworthy partner in building the AIoT digital transformation solutions. To surpass customers' expectations, NEXCOM sets itself apart by leveraging its decades of experience in industrial computing, a highly talented R&D team, and exceptional customer service. With these core strengths, NEXCOM has enabled its customers to win key projects in a diverse range of industries.

With its focus on delivering these core values to better serve customers, NEXCOM integrates its capabilities and operates six global businesses: IoT Automation Solutions (IAS), Intelligent Video Surveillance (IDS), Intelligent Platform @ Smart City (IPS), Mobile Computing Solutions

(MCS), Medical & Healthcare Informatics (MHI), Network and Communication Solutions (NCS). This strategic deployment enables NEXCOM to offer time-to-market, time-to-solution products and services without compromising on cost.

In addition, the service-to-market business model gives NEXCOM core competence in building a strong world-class service network by providing customized service, global logistics, local access, and real-time support. Operating six subsidiaries in China, Japan, Taiwan, and the United States, NEXCOM is able to better accommodate customers' requirements as well as closely work with global partners in different regions.

Partners can also be assured that NEXCOM's Taiwan-based Headquarters and subsidiary offices in China and the USA have obtained ISO 9001:2015 Certification.



IAS	IoT Automation Solutions: Industrial Automation & I4.0 Execution, Intelligent Edge, Gateway & EWR, Industrial Robot Control, EtherCAT Motion Solutions, Wireless & Embedded Solutions for Industrial IoT
IDS	Intelligent Video Surveillance: IP Video Surveillance Cameras, Mobile Cameras, ANPR/LPR Network Cameras, Panoramic Cameras, NVR Server Platform
IPS	Intelligent Platform @ Smart City: Smart City, Smart Retail, Digital Signage, Interactive Kiosks, Hospitality, Gateway, Edge AI, and ODM Customization Services
MCS	Mobile Computing Solutions: Edge AI Telematics Computer, Vehicle Telematics Computer, Railway Computer, Vehicle Mount Computer, Vehicle Mount Display, In-Vehicle Networking, In-Vehicle HDMI Extender over IP, Fitness Console
MHI	Medical and Healthcare Informatics: Total Solutions with a Variety of Medical IT Systems
NCS	Network and Communication Solutions: Cyber Security, HPC, Telecommunications, Storage, SDN/NFV, 5G, uCPE, ICS Security

Corporate Vision

To become the industrial leader in providing AIoT digital transformation solutions, NEXCOM utilizes its industry leading technology, localized customer support and worldwide logistics services. This will be achieved by:

- Great team work
- Cooperation with trusted partners
- Growth through innovation

Corporate Mission

- An AIoT digital transformation supplier in vertical application markets
- A quality partner in engineering, manufacturing and services

Business Strategy

Aiming to better support the activities of all its partners, NEXCOM divides its sales force into six dedicated business units to target rapidly expanding vertical markets. This enables each business unit to focus on strategic channel accounts and repeat order business. Moreover, NEXCOM will provide customers with co-marketing strategies, technical support, ODM services, and project support, which are frequently required everywhere.

NEXCOM has already become a business group focused on innovating comprehensive solutions for Industry 4.0. We help our customers deliver vertical solutions optimized for 5G, AI, AIoT, and Industry 4.0 solutions.

Global Fulfillment Service

Product delivery and customer support are always more effective when delivered locally. NEXCOM localizes support and provides a global customer service network to handle all aspects of global business, from presales, order taking, and system assembly to logistics. For expeditious product delivery, NEXCOM has established four regional service centers: Taiwan (for Asia), USA (for North America and South America), and China. Therefore, NEXCOM customers benefit from quality assured product assembly and four service centers.

NEXCOM has invested heavily to establish operational infrastructures, including advanced equipment and facilities, not only at its global headquarters but also at subsidiary offices. Today, each of our service centers, with ISO 9001:2008 certification, has a purpose built assembly line, RMA/ DOA center and warehouse storage capability.

Quality Assurance

Under a strict Quality Assurance System, product design and reliability are controlled to support all critical solutions, and ensure Total Quality Assurance (TQA) implementation for all NEXCOM

products and services. Additionally, NEXCOM's technical support team is aligned with ISO 27001 requirements, as they aim to provide timely feedback within 24 hours to resolve technical issues efficiently. This ensures that any potential information security incidents are addressed promptly, minimizing the impact and downtime for customers.

Green Policy

As a global citizen, NEXCOM places great importance on environmental issues. We are committed to ensuring that our products and services comply with environmental standards and regulations. NEXCOM actively responds to energy-saving and carbon reduction initiatives, prioritizes environmental protection in our operational activities, and holds certificate such as ISO 14064-1 greenhouse gas inventory and ISO 14001 environmental management system. We implement voluntary greenhouse gas inventory, reduce resource and energy consumption, and mitigate environmental risks. We also measure NEXCOM's sustainability and corporate responsibility as an Earth-friendly enterprise through ESG evaluation. NEXCOM will continue to collaborate with peers and suppliers to strive for purification standards, compatibility of technologies, and operational processes to help reduce the potential hazardous substances in our products and manufacturing processes.

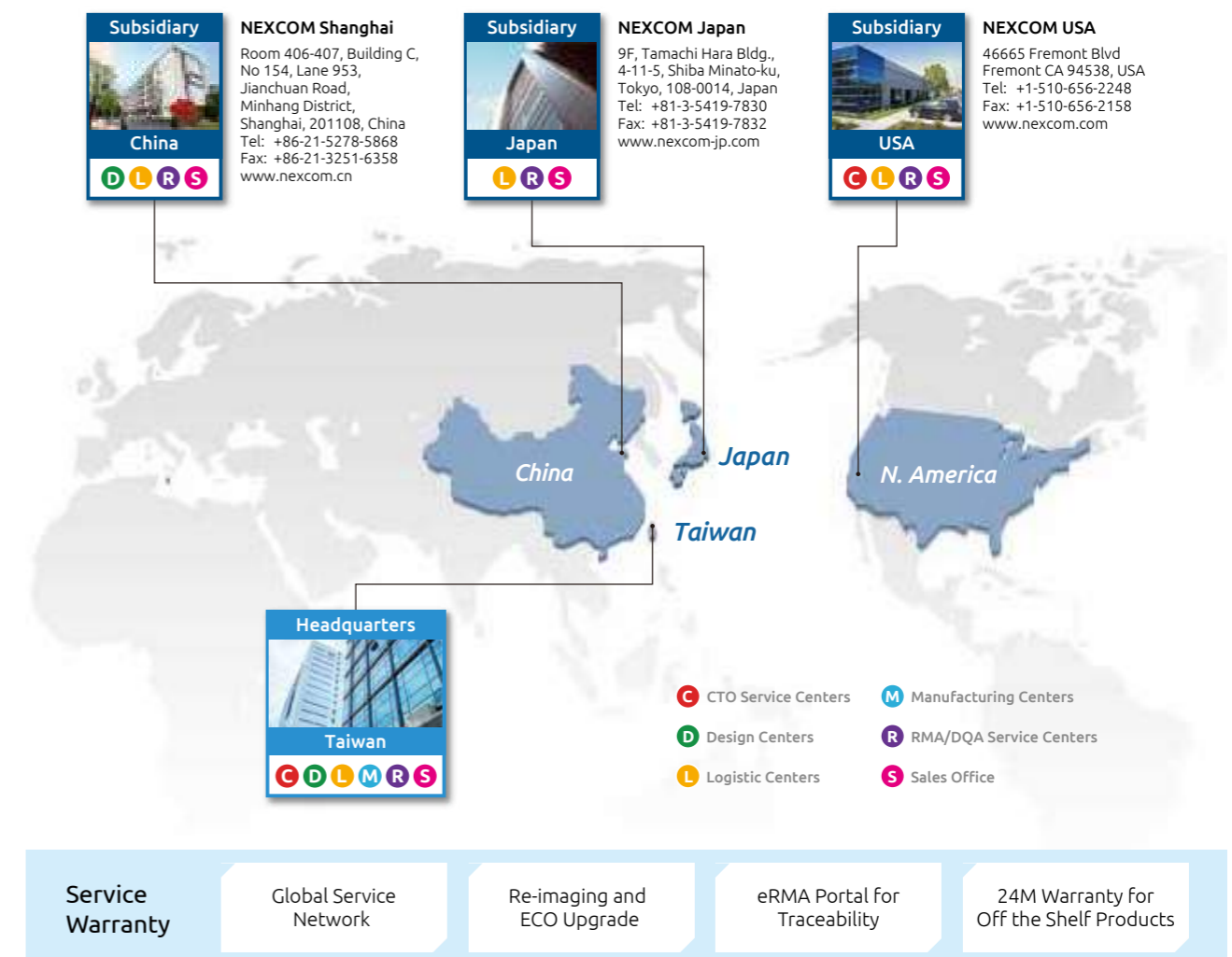

Service details may vary by country. Please contact us for more details.

Headquarters

NEXCOM International Co., Ltd.

9F, No.920, Zhongzheng Rd., Zhonghe District, New Taipei City, 23586, Taiwan, R.O.C.
Tel: +886-2-8226-7786
Fax: +886-2-8226-7782
www.nexcom.com

Asia

Taiwan

NexAIoT Co., Ltd.

Taipei Office

13F, No.922, Zhongzheng Rd.,
Zhonghe District,
New Taipei City, 23585, Taiwan, R.O.C.
Tel: +886-2-2886-7796
Fax: +886-2-8226-7926
Email: jacobhuang@nexaiot.com
www.nexaiot.com

NexAIoT Co., Ltd.

Taichung Office

16F, No.250, Sec. 2, Chongde Rd.,
Beitun Dist.,
Taichung City, 406, Taiwan, R.O.C.
Tel: +886-4-2249-1179
Fax: +886-4-2249-1172
Email: jacobhuang@nexaiot.com
www.nexaiot.com

NexCOBOT Taiwan Co., Ltd.

13F, No.916, Zhongzheng Rd.,
Zhonghe District,
New Taipei City, 23586, Taiwan, R.O.C.
Tel: +886-2-2886-7786
Fax: +886-2-2886-7726
Email: jennyshern@nexcobot.com
www.nexcobot.com

GreenBase Technology Corp.

13F, No.922, Zhongzheng Rd.,
Zhonghe District,
New Taipei City, 23586, Taiwan, R.O.C.
Tel: +886-2-2886-7786
Fax: +886-2-2886-7900
Email: vivianlin@nexcom.com.tw
www.nexcom.com.tw

DivioTec Inc.

19F-1, No.97, Sec. 4, ChongXin Rd.,
SanChong Dist.,
New Taipei City, 24161 Taiwan, R.O.C.
Tel: +886-2-8976-3077
Email: sales@diviotec.com
www.diviotec.com

AIOT CLOUD CORP.

13F, No.922, Zhongzheng Rd.,
Zhonghe District,
New Taipei City, 23586, Taiwan, R.O.C.
Tel: +886-2-2886-7786
Fax: +886-2-2886-7982
Email: support@aiotcloud.dev
www.aiotcloud.dev

EMBUX Technology Co., Ltd.

13F, No.916, Zhongzheng Rd.,
Zhonghe District,
New Taipei City, 23586, Taiwan, R.O.C.
Tel: +886-2-2886-7786
Fax: +886-2-2886-7782
Email: info@embux.com
www.embux.com

TMR Technologies Co., Ltd.

13F, No.916, Zhongzheng Rd.,
Zhonghe District,
New Taipei City, 23586, Taiwan, R.O.C.
Tel: +886-2-2886-7786
Fax: +886-2-2886-7782
Email: services@tmrtek.com
www.tmrtek.com

China

NEXCOM Shanghai

Room 406-407, Building C, No 154, Lane 953,
Jianchuan Road, Minhang District,
Shanghai, 201108, China
Tel: +86-21-5278-5868
Fax: +86-21-3251-6358
Email: sales@nexcom.cn
www.nexcom.cn

NEXCOM Surveillance Technology Corp.

Floor 8, Building B3, Xiufeng Industrial Zone,
GanKeng Community, Buji Street,
LongGang District,
ShenZhen, 518112, China
Tel: +86-755-8364-7768
Fax: +86-755-8364-7738
Email: steveyang@nexcom.com.tw
www.nexcom.cn

Beijing NexGem

Technology Co.,Ltd.

Floor 2, Gemotech Building,
No.1, Development Rd.,
Changping International
Information Industry Base,
Changping District,
Beijing, 102206, China
Tel: +86-10-8072-2025
Fax: +86-10-8072-2022
Email: sales@nexgemo.cn
www.nexgemo.cn

Japan

NEXCOM Japan

9F, Tamachi Hara Bldg.,
4-11-5, Shiba Minato-ku,
Tokyo, 108-0014, Japan
Tel: +81-3-5419-7830
Fax: +81-3-5419-7832
Email: sales@nexcom-jp.com
www.nexcom-jp.com

America

USA

NEXCOM USA

46665 Fremont Blvd
Fremont CA 94538, USA
Tel: +1-510-656-2248
Fax: +1-510-656-2158
Email: sales@nexcom.com
www.nexcom.com



Committed to Customer Success

Please verify specifications before quoting. This guide is intended for reference purpose only.
All product specifications and information are subject to change without notice.

No part of this publication may be reproduced in any form or by any means without prior written permission of the publisher.
All brand and product names are registered trademarks of their respective companies.

©NEXCOM International Co., Ltd. 2023